

# SG 1011

---

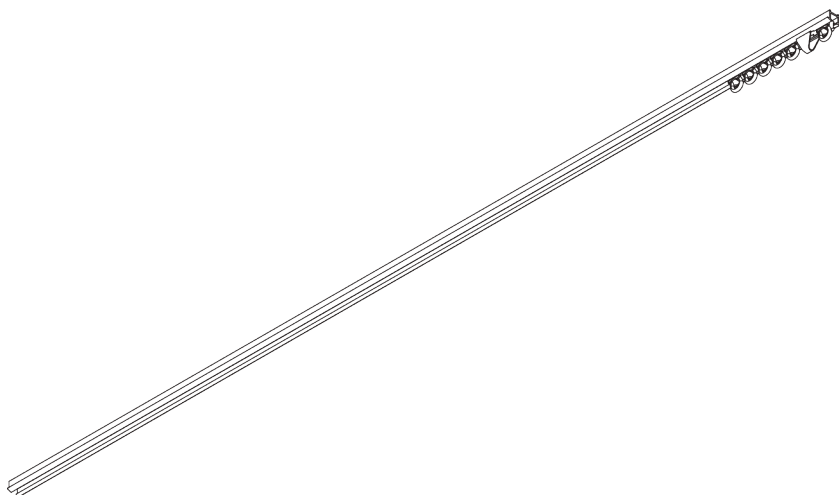

## PRODUKTINFORMATIONEN

- **Bedienung:** Hand
- **Grösse:** S
- **Montage:** Nut (Center SG 7550)
- **Farben:** weiss RAL 9016 oder Aluminium farblos eloxiert, Sonderfarben möglich
- **Stoffe:** siehe Silent Gliss Stoffkollektion

### **Merkmale:**

- Vorgebohrtes Profil
- Biegbar

# SYSTEMSPEZIFIKATIONEN

## A. PROFIL

Profil- und  
Biegeinformationen

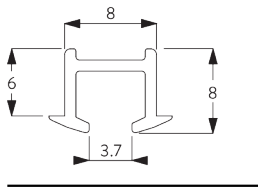

SG 101p

Profil

Radius:  
✓ 6 cm, 10 cm

## B. MASSAUFNAHME

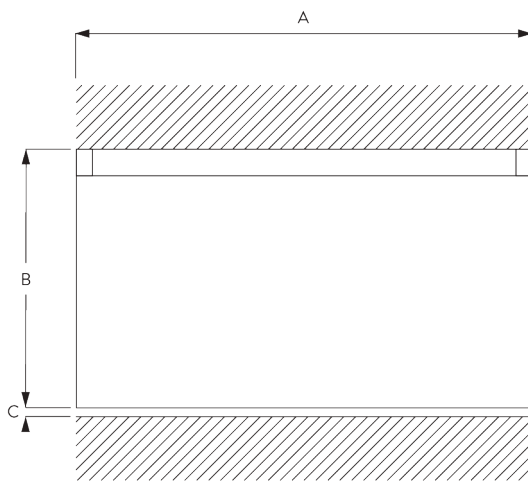

A: Systembreite

B: Systemhöhe

C: Abstand zwischen Boden und Behang

# MONTAGE

## A. MONTAGE- INFORMATIONEN

Detaillierte Montageinformationen siehe  
Silent Gliss Website

Montagepunkte

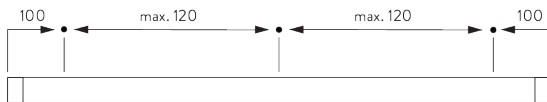

Profilschutz

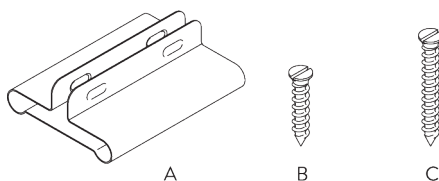

A: Profilschutz SG 7002

B: Spezialschraube SG 3019 / 12 mm

C: Spezialschraube SG 3025 / 18 mm

## B. NUT MONTAGE

Direkt ins Holz

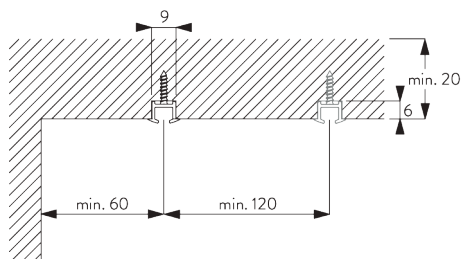

Nut Kanal: 6 x 9 mm

# KOMPONENTEN

## A. STANDARD KOMPONENTEN

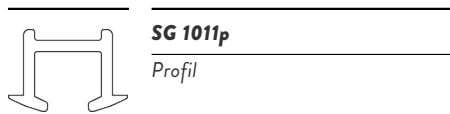

**SG 1011p**

Profil

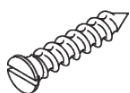

**SG 3019**

Spezierschraube



**SG 3070**

Ösenfeststeller

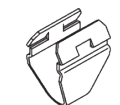

**SG 3085**

Verschlussfeder



**SG 3533**

Gleiter



**SG 3599**

Haken

## B. OPTIONALE KOMPONENTEN

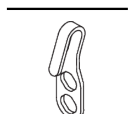

**SG 3012**

Haken

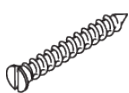

**SG 3025**

Spezierschraube

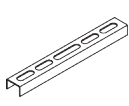

**SG 3063**

Profilverbinder



**SG 3511**

Gleiter



**SG 3534**

Gleiter 3533 an der Stange



**SG 3535**

Gleiter



**SG 3537**

Gleiter

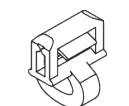

**SG 3547**

Clic-Gleiter

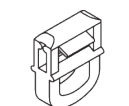

**SG 3548**

Gleiter



**SG 3549**

Klickgleiter mit Haken



**SG 3582**

Haken

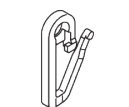

**SG 3598**

Öse

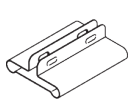

**SG 7002**

Profilschutz

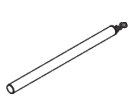

**SG 10430**

Schleuderstab 50 cm

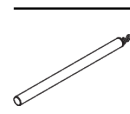

**SG 10431**

Schleuderstab 75 cm

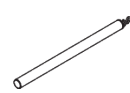

**SG 10432**

Schleuderstab 100 cm

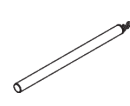

**SG 10433**

Schleuderstab 125 cm

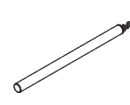

**SG 10434**

Schleuderstab 150 cm

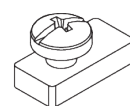

**SG 11335**

Feststeller