

SG 1060

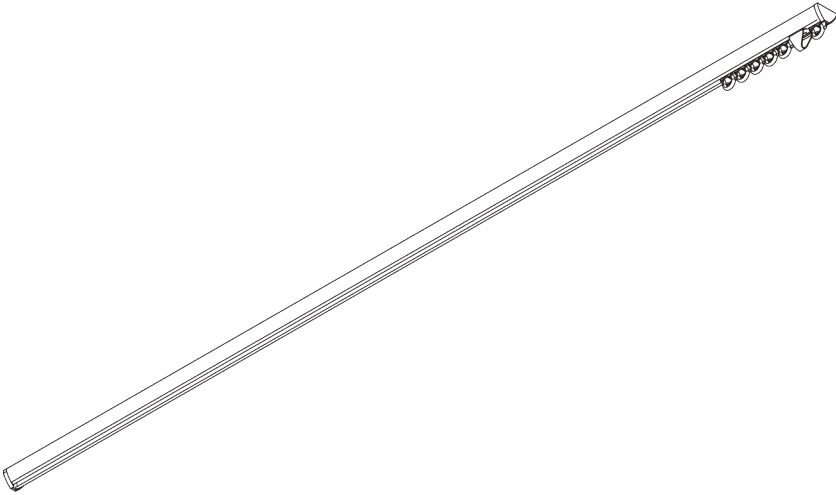

PRODUKTINFORMATIONEN

- **Bedienung:** Hand
- **Grösse:** S
- **Montage:** Decke
- **Farben:** weiss RAL 9016 oder Aluminium farblos eloxiert, Sonderfarben möglich
- **Stoffe:** siehe Silent Gliss Stoffkollektion

Merkmale:

- Biegbar

SYSTEMSPEZIFIKATIONEN

A. PROFIL

Profil- und
Biegeinformationen

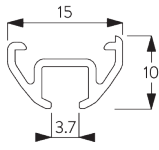

SG 1060p

Profil

Radius:
✓ 6 cm, 10 cm, 12 cm,
20 cm, >30 cm

B. MASSAUFNAHME

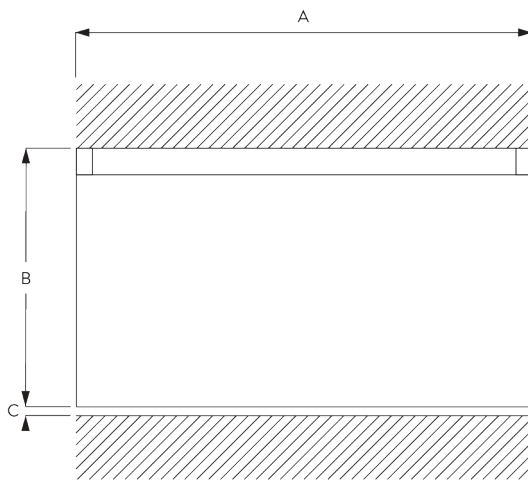

A: Systembreite

B: Systemhöhe

C: Abstand zwischen Boden und Behang

MONTAGE

A. MONTAGE- INFORMATIONEN

Detaillierte Montageinformationen siehe
Silent Gliss Website

Montagepunkte

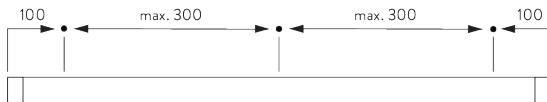

B. DECKEN- MONTAGE

Spanner SG 3060

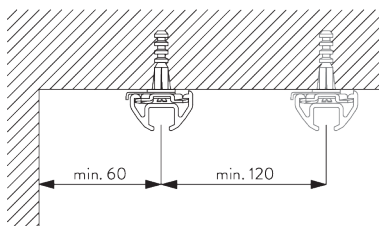

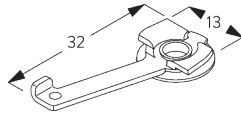





SG 3060



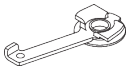
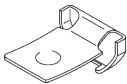

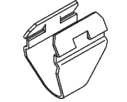



Spanner

KOMPONENTEN

A. STANDARD KOMPONENTEN

	SG 1060p Profil
	SG 3060 Spanner
	SG 3061 Enddeckel
	SG 3070 Ösenfeststeller
	SG 3085 Verschlussfeder
	SG 3533 Gleiter
	SG 3599 Haken

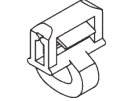
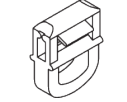
B. OPTIONALE KOMPONENTEN

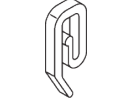
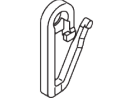
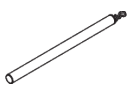
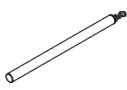
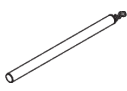
	SG 3012 Haken
	SG 3062 Profilverbinder
	SG 3511 Gleiter
	SG 3534 Gleiter 3533 an der Stange
	SG 3535 Gleiter
	SG 3537 Gleiter
	SG 3547 Clic-Gleiter
	SG 3548 Gleiter
	SG 3549 Klickgleiter mit Haken
	SG 3582 Haken
	SG 3598 Öse
	SG 10430 Schleuderstab 50 cm
	SG 10431 Schleuderstab 75 cm
	SG 10432 Schleuderstab 100 cm

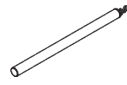
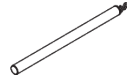
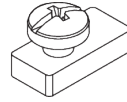
	SG 10433 Schleuderstab 125 cm
	SG 10434 Schleuderstab 150 cm
	SG 11335 Feststeller