

SG 6011



PRODUKTINFORMATIONEN

- **Bedienung:** Hand
- **Grösse:** S-M
- **Montage:** Nut (Center SG 7550)
- **Farben:** weiss RAL 9016 oder Aluminium farblos eloxiert, Sonderfarben möglich
- **Stoffe:** siehe Silent Gliss Stoffkollektion

Merkmale:

- 2-Komponenten-Gleiter-Technologie (2C)
- Vorgebohrtes Profil
- Biegbar

SYSTEMSPEZIFIKATIONEN

A. PROFIL

Profil- und
Biegeinformationen

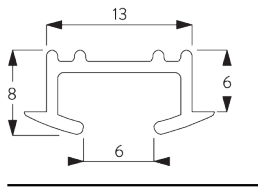

SG 6011p

Profil

Radius:
10 cm, 20 cm

B. MASSAUFNAHME

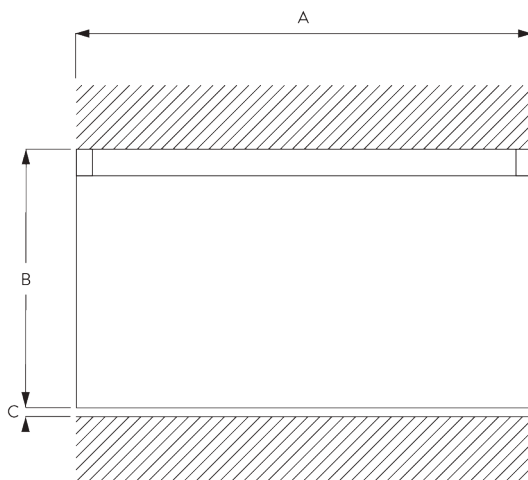

A: Systembreite

B: Systemhöhe

C: Abstand zwischen Boden und Behang

MONTAGE

A. MONTAGE- INFORMATIONEN

Detaillierte Montageinformationen siehe
Silent Gliss Website

Montagepunkte

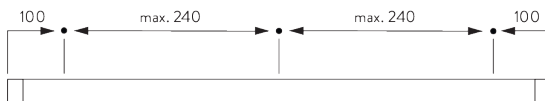

B. NUT MONTAGE



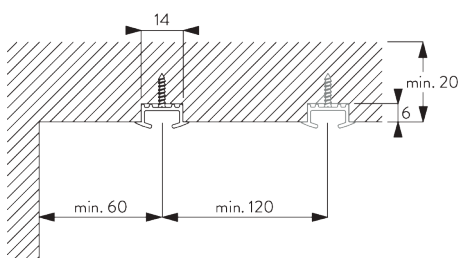

Direkt ins Holz





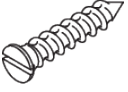

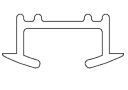
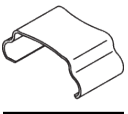



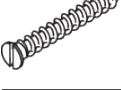
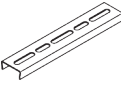

Nut Kanal: 6 x 14 mm

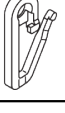
KOMPONENTEN

A. STANDARD KOMPONENTEN

	SG 3019 Speziellschraube
	SG 3599 Haken
	SG 6011p Profil
	SG 6015 Verschlussfeder
	SG 6065 Feststeller
	SG 11300 2C-Gleiter

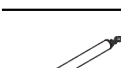
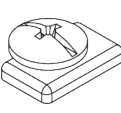
B. OPTIONALE KOMPONENTEN

	SG 3012 Haken
	SG 3025 Speziellschraube
	SG 3067 Profilverbinder
	SG 3582 Haken
	SG 3598 Öse
	SG 6057 Gleiter
	SG 6082 Gleiter
	SG 10430 Schleuderstab 50 cm
	SG 10431 Schleuderstab 75 cm
	SG 10432 Schleuderstab 100 cm
	SG 10433 Schleuderstab 125 cm
	SG 10434 Schleuderstab 150 cm
	SG 11295 Feststeller
	SG 11301 2C-Gleiter am Strip

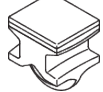
	SG 11305 2C-Gleiter für direktes Annähen
---	--

