

SG 6170

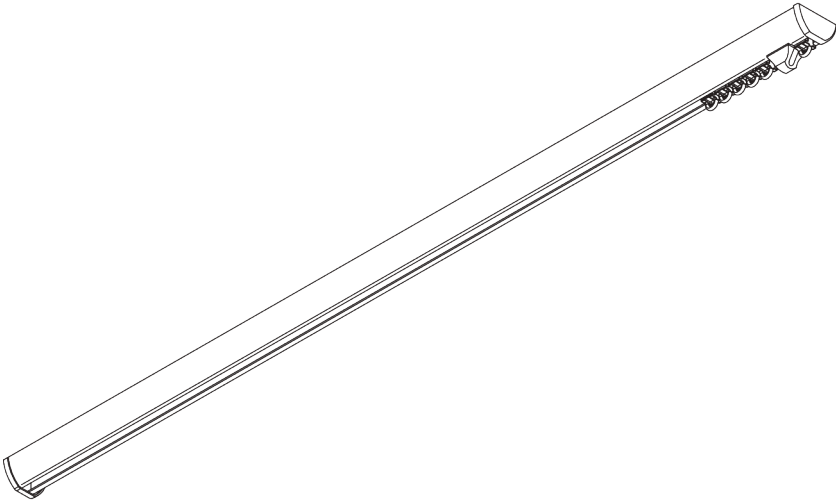
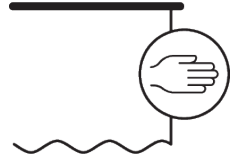

PRODUKTINFORMATIONEN

- **Bedienung:** Hand
- **Grösse:** M - L
- **Montage:** Decke
- **Farben:** weiss RAL 9016 oder Aluminium farblos eloxiert, Sonderfarben möglich
- **Stoffe:** siehe Silent Gliss Stoffkollektion

Merkmale:

- 2-Komponenten-Gleiter-Technologie (2C)
- Wave (2C)
- Biegbar

SYSTEMSPEZIFIKATIONEN

A. PROFIL

Profil- und
Biegeinformationen

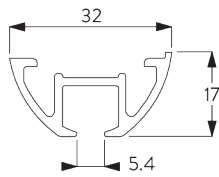

SG 6170p

Profil

Radius:
✓ >25 cm

B. MASSAUFNAHME

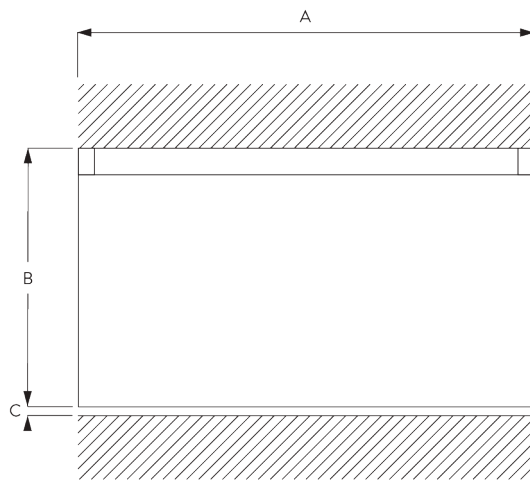

A: Systembreite

B: Systemhöhe

C: Abstand zwischen Boden und Behang

MONTAGE

A. MONTAGE- INFORMATIONEN

Montagepunkte

Detaillierte Montageinformationen siehe
Silent Gliss Website

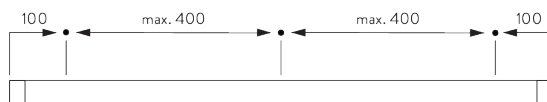

B. DECKEN- MONTAGE

Spanner SG 3004

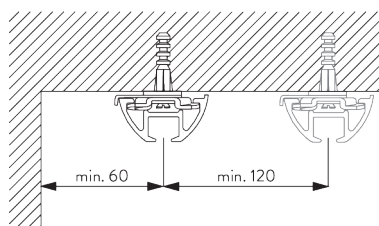

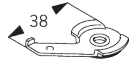

SG 3004
Spanner

SYSTEMOPTIONEN

A. WAVE

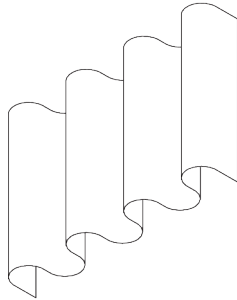

SG 11295

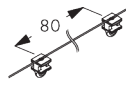

SG 11302



SG 2255



SG 2256

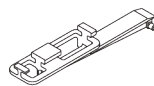

SG 6364



SG 6365

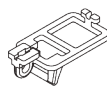

SG 6366

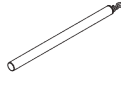

SG 10430-34

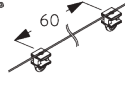

SG 11303

Standard Komponenten:

- SG 11295 Feststeller
- SG 11302 Wave-2C-Gleiterkordel 80 mm

Optionale Komponenten (min. Radius >30 cm):

- SG 2255 Bremse
- SG 2256 Bremse
- SG 6364 Wave Verlängerung
- SG 6365 Wave Hänger
- SG 6366 Wave Träger für Schleuderstab
- SG 10430-34 Schleuderstab
- SG 11303 Wave-2C-Gleiterkordel 60 mm



SG 3582

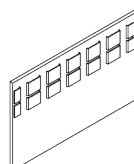

SG 6349

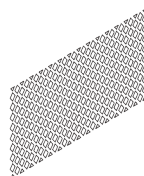

SG 6363

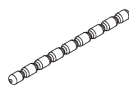

SG 10075



SG 10076

Vorhang Komponenten:

- SG 3582 Haken
- SG 6349 Wave Vorhangband
- SG 6363 Wave Bügelband
- SG 10075 Bleischnur 50 gr/m
- SG 10076 Beschwerung Seitensaum

Wave Paketbreite - 2C-Gleiterkordel (Standard Komponenten)

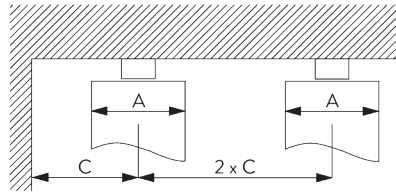
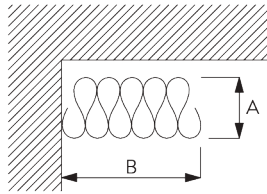

A = Pakettiefe
B = Paketbreite
C = Min. Abstand







2C-Gleiterkordel SG 11302	Zwischen- laschen	Stoffzugabe	Pakettiefe A	Paketbreite B*	Min. Abstand C
80	6	~2.1	140	180 pro Meter System	90
80	7	~2.3	160	180 pro Meter System	100

2C-Gleiterkordel SG 11303	Zwischen- laschen	Stoffzugabe	Pakettiefe A	Paketbreite B*	Min. Abstand C
60	4	~2.1	100	230 pro Meter System	70
60	5	~2.3	120	230 pro Meter System	80

*Paketgröße B vergrößert sich um 150 mm pro Vorhangpaket bei Verwendung des optionalen Verlängerungsarms SG 6364!

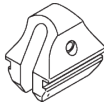

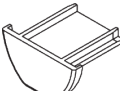

KOMPONENTEN

A. STANDARD KOMPONENTEN

	SG 3004 Spanner
	SG 3599 Haken
	SG 6065 Feststeller
	SG 6086 Verschlussfeder
	SG 6170p Profil
	SG 6172 Enddeckel
	SG 11300 2C-Gleiter

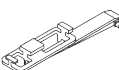
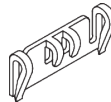
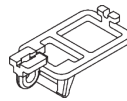
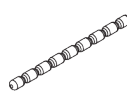
B. OPTIONALE KOMPONENTEN

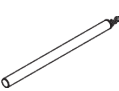
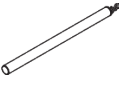
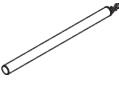
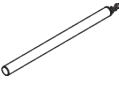
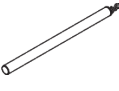
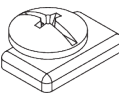
	SG 2255 Brems
	SG 2256 Brems
	SG 3008 Profilverbinder
	SG 3012 Haken
	SG 3582 Haken
	SG 6004 Öse
	SG 6005 Haken
	SG 6053 Verschlussfeder
	SG 6082 Gleiter
	SG 6094 Roller
	SG 6098 Roller
	SG 6283 Roller
	SG 6349 Wave Vorhangband
	SG 6363 Wave Bügelband

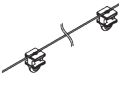
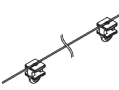
	SG 6364 Wave Verlängerungsarm
	SG 6365 Wave Hänger
	SG 6366 Wave Mitnehmer für Schleuderstab
	SG 10075 Bleischnur 50 gr/m
	SG 10076 Beschwerung Seitensaum
	SG 10430 Schleuderstab 50 cm
	SG 10431 Schleuderstab 75 cm
	SG 10432 Schleuderstab 100 cm
	SG 10433 Schleuderstab 125 cm
	SG 10434 Schleuderstab 150 cm
	SG 11295 Feststeller
	SG 11301 2C-Gleiter am Strip
	SG 11302 Wave-2C-Gleiterkordel 80 mm
	SG 11303 Wave-2C-Gleiterkordel 60 mm



SG 11305

2C-Gleiter für direktes Annähen
