

SG 6244

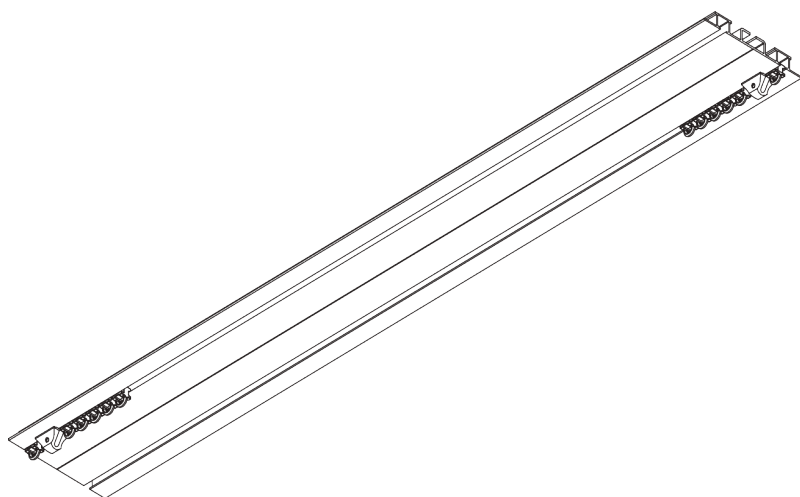
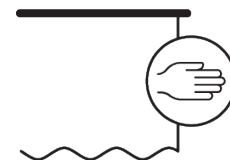

PRODUKTINFORMATIONEN

- **Bedienung:** Hand
- **Grösse:** M - L
- **Montage:** Nut
- **Farben:** weiss RAL 9016, Sonderfarben möglich
- **Stoffe:** siehe Silent Gliss Stoffkollektion

Merkmale:

- 2-Komponenten-Gleiter-Technologie (2C)

SYSTEMSPEZIFIKATIONEN

A. PROFIL

Profilinformationen

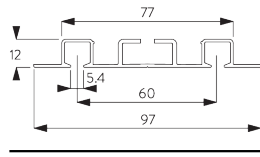

SG 6244p

Profil

B. MASSAUFNAHME

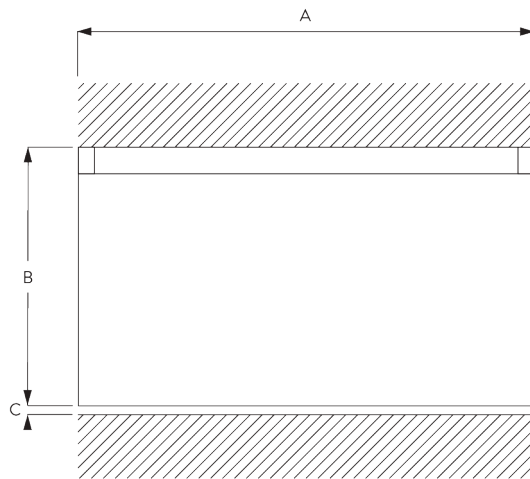

A: Systembreite

B: Systemhöhe

C: Abstand zwischen Boden und Behang

MONTAGE

A. MONTAGE- INFORMATIONEN

Detaillierte Montageinformationen siehe
Silent Gliss Website

Montagepunkte

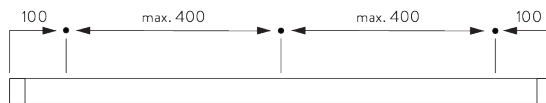

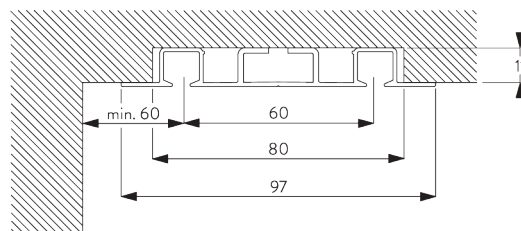

B. NUT MONTAGE

Direkte Montage







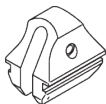





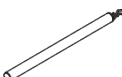
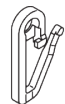
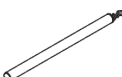

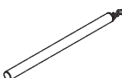

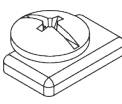

KOMPONENTEN

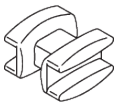
A. STANDARD KOMPONENTEN

	SG 3599 Haken
	SG 6065 Feststeller
	SG 6086 Verschlussfeder
	SG 6244p Profil
	SG 11300 2C-Gleiter

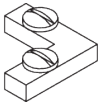
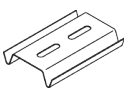
B. OPTIONALE KOMPONENTEN

	SG 3581 Haken		SG 10430 Schleuderstab 50 cm
	SG 3582 Haken		SG 10431 Schleuderstab 75 cm
	SG 3598 Öse		SG 10432 Schleuderstab 100 cm
	SG 6004 Öse		SG 10433 Schleuderstab 125 cm
	SG 6005 Haken		SG 10434 Schleuderstab 150 cm
	SG 6053 Verschlussfeder		SG 11295 Feststeller
	SG 6057 Gleiter		SG 11305 2C-Gleiter für direktes Annähen
	SG 6082 Gleiter		
	SG 6094 Roller		
	SG 6098 Roller		
	SG 6240 Roller		
	SG 6246 Eckverbinder		
	SG 6248 Profilverbinder		
	SG 6283 Roller		

