

# SG 6250

---

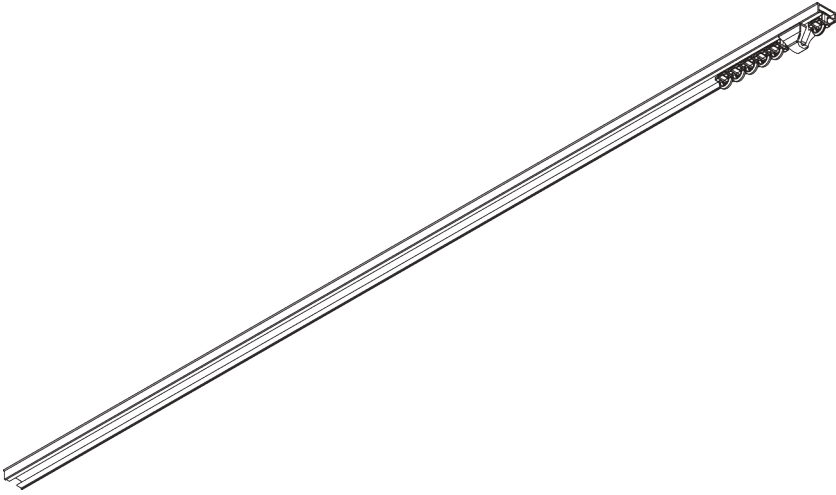

## PRODUKTINFORMATIONEN

- **Bedienung:** Hand
- **Grösse:** S - M
- **Montage:** Nut
- **Farben:** weiss RAL 9016
- **Stoffe:** siehe Silent Gliss Stoffkollektion

### **Merkmale:**

- 2-Komponenten-Gleiter-Technologie (2C)
- Wave (2C)
- Biegbar

# SYSTEMSPEZIFIKATIONEN

## A. PROFIL

Profil- und  
Biegeinformationen

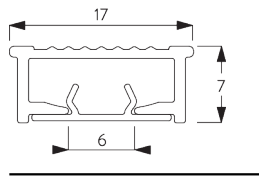

SG 11220

Profil mit Abdeckung

✓ Radius:  
10 cm, 20 cm

## B. MASSAUFNAHME

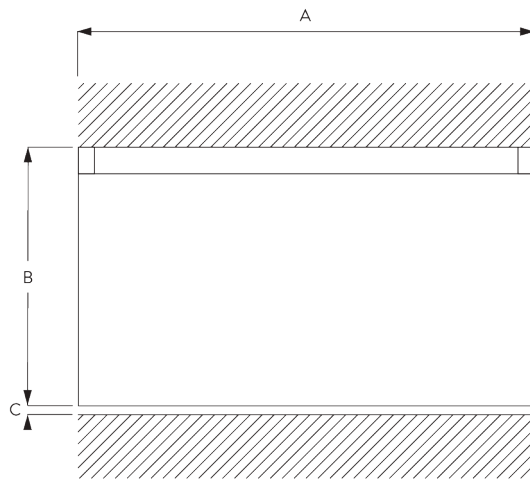

A: Systembreite

B: Systemhöhe

C: Abstand zwischen Boden und Behang

# MONTAGE

## A. MONTAGE- INFORMATIONEN

Detaillierte Montageinformationen siehe  
Silent Gliss Website

## B. NUT MONTAGE

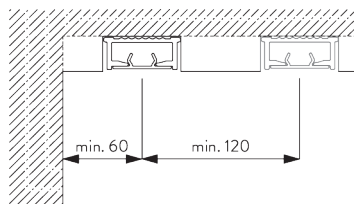

Klebmontage ausschliesslich auf Rohbeton.

# SYSTEMOPTIONEN

## A. WAVE

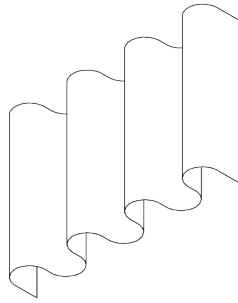

SG 11295

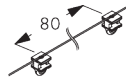

SG 11302

### Standard Komponenten:

- SG 11295 Feststeller
- SG 11302 Wave-2C-Gleiterkordel 80 mm

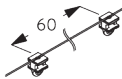

SG 11303

### Optionale Komponenten:

- SG 11303 Wave-2C-Gleiterkordel 60 mm



SG 3582

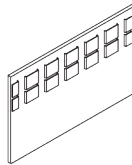

SG 6349

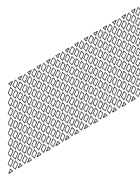

SG 6363

### Vorhang Komponenten:

- SG 3582 Haken
- SG 6349 Wave Vorhangband
- SG 6363 Wave Bügelband
- SG 10075 Bleischnur 50 gr/m
- SG 10076 Beschwerung Seitensaum



SG 10075

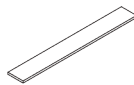

SG 10076

Wave Paketbreite - 2C-Gleiterkordel (Standard Komponenten)

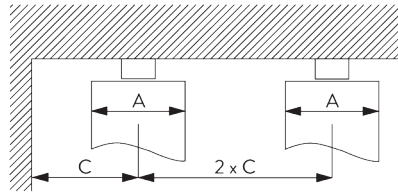
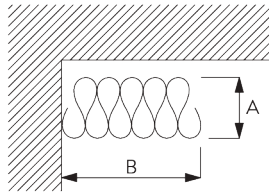

A = Pakettiefe  
 B = Paketbreite  
 C = Min. Abstand

2C-Gleiterkordel SG 11302	Zwischen- laschen	Stoffzugabe	Pakettiefe A	Paketbreite B*	Min. Abstand C
80	6	~2.1	140	180 pro Meter System	90
80	7	~2.3	160	180 pro Meter System	100











2C-Gleiterkordel SG 11303	Zwischen- laschen	Stoffzugabe	Pakettiefe A	Paketbreite B*	Min. Abstand C
60	4	~2.1	100	230 pro Meter System	70
60	5	~2.3	120	230 pro Meter System	80

# KOMPONENTEN

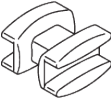
## A. STANDARD KOMPONENTEN

	<b>SG 3599</b> Haken
	<b>SG 6065</b> Feststeller
	<b>SG 6245</b> Verschlussfeder
	<b>SG 11220</b> Profil mit Abdeckung
	<b>SG 11300</b> 2C-Gleiter

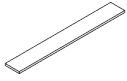
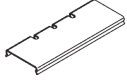
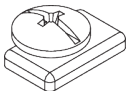
## B. OPTIONALE KOMPONENTEN

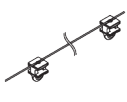
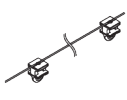
	<b>SG 3012</b> Haken
	<b>SG 3582</b> Haken
	<b>SG 3598</b> Öse
	<b>SG 6057</b> Gleiter
	<b>SG 6082</b> Gleiter
	<b>SG 6349</b> Wave Vorhangband
	<b>SG 6363</b> Wave Bügelband
	<b>SG 10075</b> Bleischnur 50 gr/m
	<b>SG 10076</b> Beschwerung Seitensaum
	<b>SG 11222</b> Profilverbinder
	<b>SG 11295</b> Feststeller
	<b>SG 11301</b> 2C-Gleiter am Strip
	<b>SG 11302</b> Wave-2C-Gleiterkordel 80 mm
	<b>SG 11303</b> Wave-2C-Gleiterkordel 60 mm

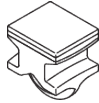
	<b>SG 11305</b> 2C-Gleiter für direktes Annähen
---	--





