

SG 4840

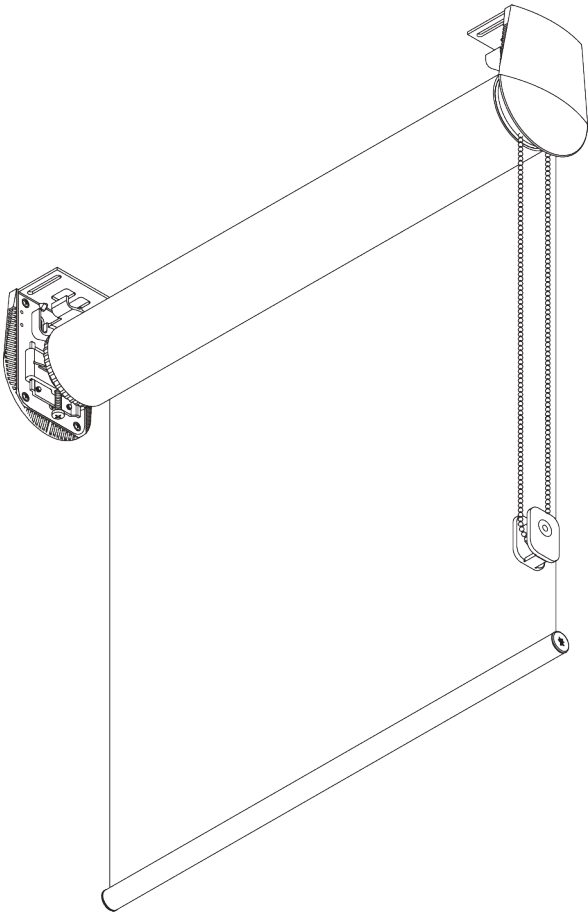
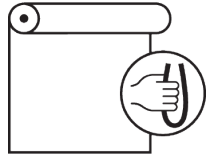

PRODUKTINFORMATIONEN

- **Bedienung:** Kette
- **Grösse:** L
- **Montage:** Decke, Wand, Nische
- **Farben:** weiss RAL 9016 oder Aluminium farblos eloxiert, Sonderfarben möglich
- **Stoffe:** siehe Silent Gliss Stoffkollektion

Merkmale:

- Rostfreie Stahlkugellkette
- Einstellbare Edelstahl-Träger zur vertikalen Ausrichtung des Stoffs

SYSTEMSPEZIFIKATIONEN

A. MASSE / GEWICHT

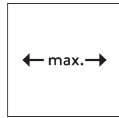

Rohr SG 4901: 4 m
Rohr SG 4957: 5 m

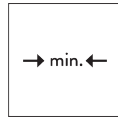

50 cm

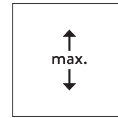

Rohr SG 4901: 6 m
Rohr SG 4957: 3.75 m



15 m²



Rohr SG 4901: 12.5 kg
Rohr SG 4957: 9.5 kg

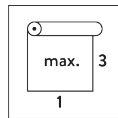

Empfohlenes Breiten- /
Höhenverhältnis
max. 1:3

Maximale Anlagenfläche

		A →								
		2 m	2.5 m	3 m	3.5 m	4 m	4.5 m	5 m		
B ↓	2 m	●	●	●	●	○	○	○		
	2.5 m	●	●	●	●	○	○	○		
	3 m	●	●	●	●	○	○	○		
	3.5 m	●	●	●	●	○				
	4 m	●	●	●	●					
	4.5 m	●	●	●						
	5 m	●	●	●						
	5.5 m	●	●		max. 15 m ²					
6 m	●	●								

● SG 4901 (ø 80 mm)
○ SG 4957 (ø 110 mm)

B. PROFIL

Profilinformationen

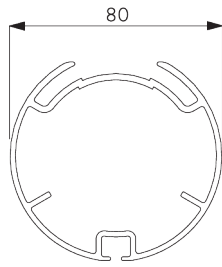

SG 4901

Rohr ø 80 mm

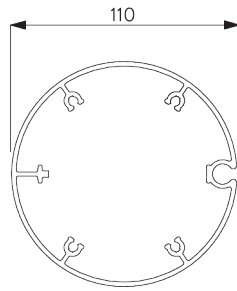

SG 4957

Rohr ø 110 mm

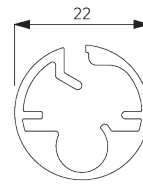

SG 10760

Beschwerung

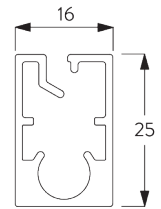

SG 10770

Beschwerung

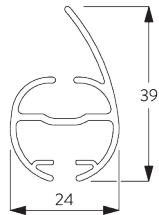

SG 4903

Beschwerung

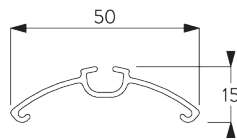

SG 4902

Profil

C. MASSAUFNAHME

inkl. Trägerabdeckung
(15 mm)

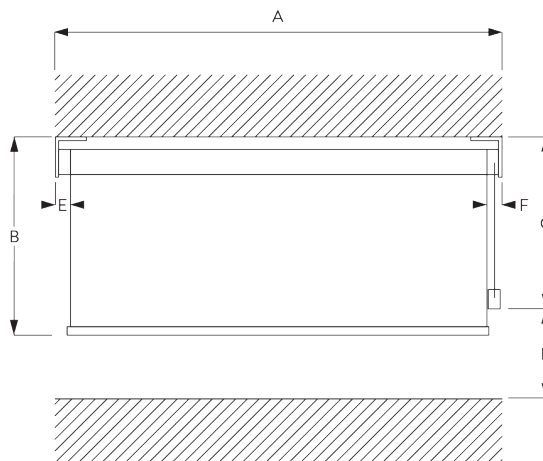

A: Systembreite

B: Systemhöhe

C: Kettenhöhe

D: Kindersicherung SG 10731 min. 150 cm über Boden

Rohr SG 4901 (ø 80 mm):

E: Lichtspalt: 44 mm

F: Lichtspalt Antriebsseite: 40 mm

Rohr SG 4957 (ø 110 mm):

E: Lichtspalt: 42 mm

F: Lichtspalt Antriebsseite: 42 mm

Bemerkung:

Alle Masse beinhalten 15 mm für die Trägerabdeckung pro Seite!

MONTAGE

A. MONTAGE- INFORMATIONEN

Detaillierte Montageinformationen siehe
Silent Gliss Website

Montagepunkte



*30 mm ohne Abdeckung

*43 mm mit Abdeckung

**Einstellbare Träger
(für vertikale
Ausrichtung)**

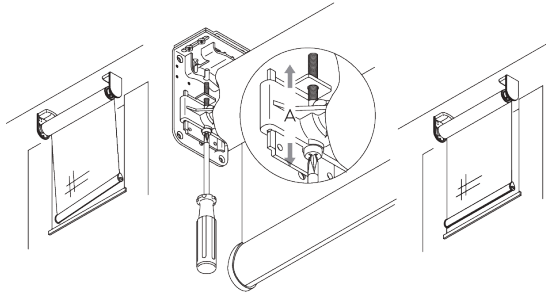

Vertikale Ausrichtung des Stoffes an den Fensterrahmen.

**B. DECKEN-
MONTAGE**

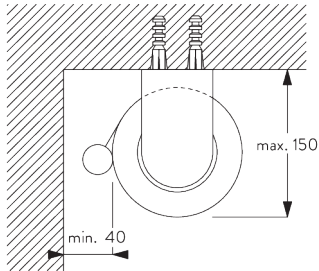

Rohr SG 4901 (ø 80 mm)

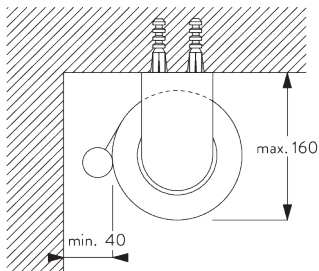

Rohr SG 4957 (ø 110 mm)

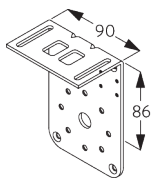

SG 4904
Träger (Set SG 4949)

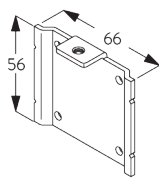

SG 4906
Platte (Set SG 4949)

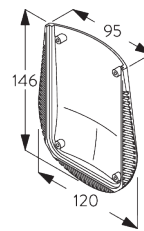

SG 4956
Trägerabdeckung

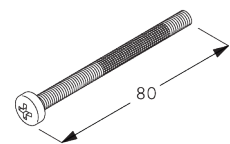

SG 4966
Spezialschraube (Set
SG 4949)

C. WANDMONTAGE

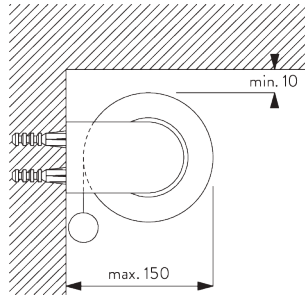

Rohr SG 4901 (ø 80 mm)

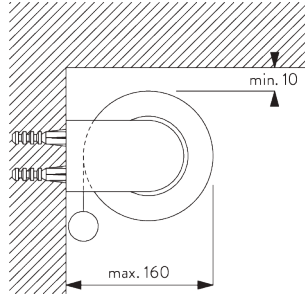

Rohr SG 4957 (ø 110 mm)

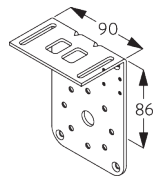

SG 4904
Träger (Set SG 4949)

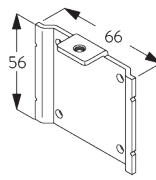

SG 4906
Platte (Set SG 4949)

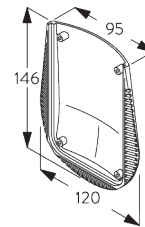

SG 4956
Trägerabdeckung

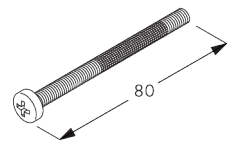

SG 4966
Spezialschraube (Set SG 4949)

D. NISCHEN- MONTAGE

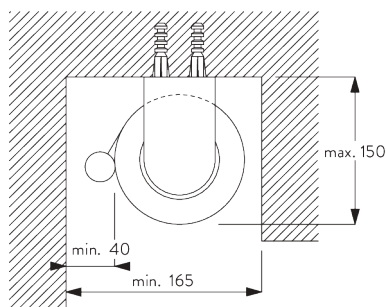

Rohr SG 4901 (ø 80 mm)

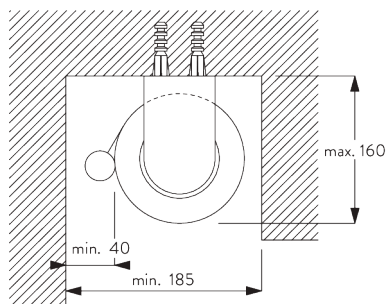

Rohr SG 4957 (ø 110 mm)

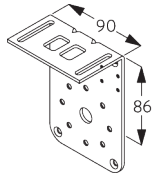

SG 4904
Träger (Set SG 4949)

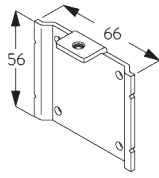

SG 4906
Platte (Set SG 4949)

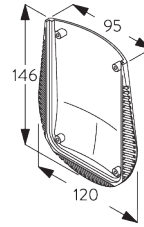

SG 4956
Trägerabdeckung

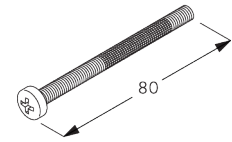

SG 4966
Spezierschraube (Set SG 4949)

**E. SEITLICHE
VERSPANNUNG**

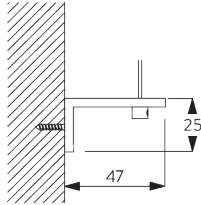

SG 3036
Winkel 47 mm

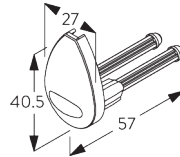
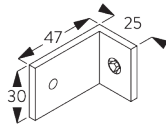

SG 4944
Enddeckel

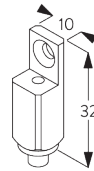

SG 4946
Drahtseilclip

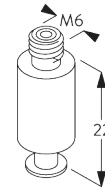

SG 4947
Drahtseilclip

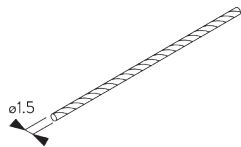

SG 4948
Draht Seitenführung ø 1.5 mm

SYSTEMOPTIONEN

**A. ABROLL-
RICHTUNG**

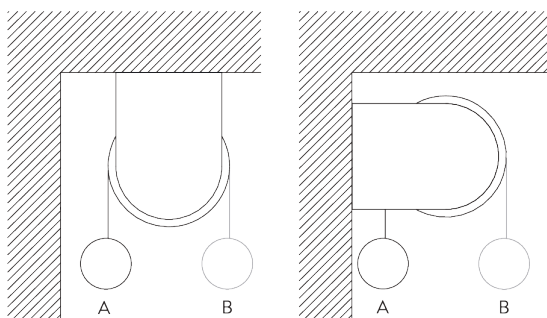

A: Fensterseitiges Stoffabrollen (Standard)
B: Raumseitiges Stoffabrollen (Option)

B. SEITLICHE VERSANNUNG

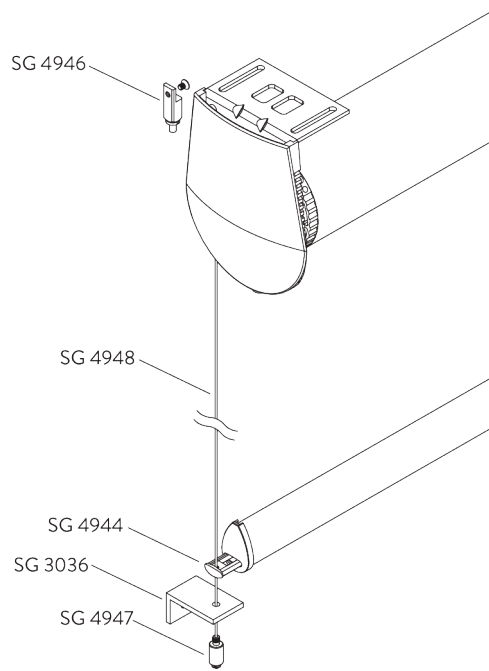

Zubehör:

- 2x SG 3036 Winkel 47 mm
- 2x SG 4944 Enddeckel Seitenführung
- 2x SG 4946 Drahtseilclip
- 2x SG 4947 Drahtseilclip
- 2x SG 4948 Draht Seitenführung \varnothing 1.5 mm

Bemerkung:

- Bei Verspannung vergrößert sich der Lichtspalt
- Bis 15° Neigung von der Vertikalen

C. MONTAGE- PLATTEN

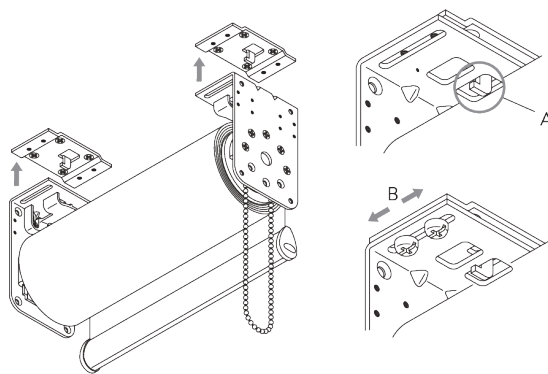

- A: Montageplatten SG 4972 tragen das Gewicht des Systems
- B: Träger können seitlich bis zu 18 mm verstellt werden

D. EINSTELLBARER END-STOP

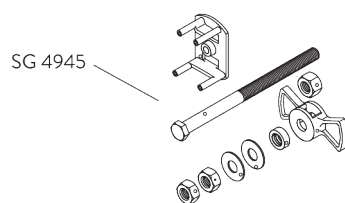

KOMPONENTEN

A. STANDARD KOMPONENTEN

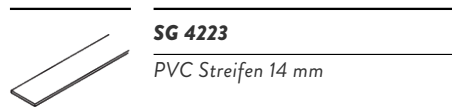

SG 4223
PVC Streifen 14 mm

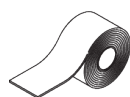

SG 4226
Doppelklebeband 30 mm



SG 4845
Stahlkugellkette \varnothing 4.5 mm



SG 4901
Rohr \varnothing 80 mm



SG 4902
Profil

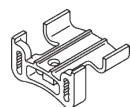

SG 4908
Endstop



SG 4914
Rohr Adapter

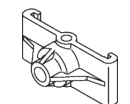

SG 4915
Abstützung

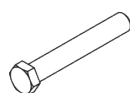

SG 4939
Achse



SG 4941
Getriebe Set

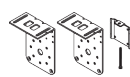

SG 4949
Trägerset



SG 4956
Trägerabdeckung

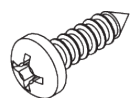

SG 10503
Linsenschraube 3.5x13

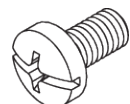

SG 10505
Linsenschraube Freedrive M4x8

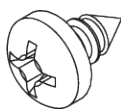

SG 10507
Linsenschraube 3.5x6.5

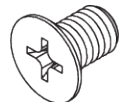

SG 10509
Senkschraube M5x8



SG 10731
Kindersicherheitshalterset



SG 10760
Beschwerung



SG 10761
Enddeckel

B. OPTIONALE KOMPONENTEN

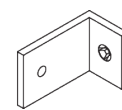

SG 3036
Winkel 47 mm



SG 4903
Beschwerung



SG 4909
Getriebe

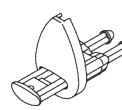

SG 4944
Enddeckel

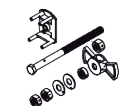

SG 4945
Endstop

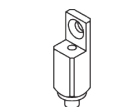

SG 4946
Drahtseilclip

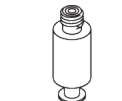

SG 4947
Drahtseilclip



SG 4948
Draht Seitenführung \varnothing 1.5 mm

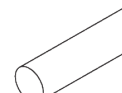

SG 4951
Beschwerung \varnothing 8 mm



SG 4957
Rohr \varnothing 110 mm

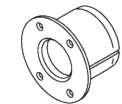

SG 4958
Rohr Adapter

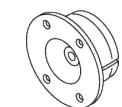

SG 4961
Rohr Adapter

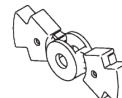

SG 4965
Flansch

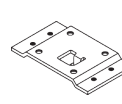

SG 4972
Montageplatte

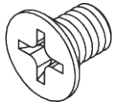

SG 10502

Senkschraube M4x6

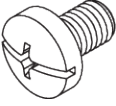

SG 10504

Linsenschraube Freedrive M5x8

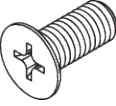

SG 10508

Senkschraube M5x12

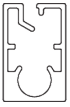

SG 10770

Beschwerung



SG 10771

Enddeckel



SG 11178

Enddeckel
