

# SG 4880

---

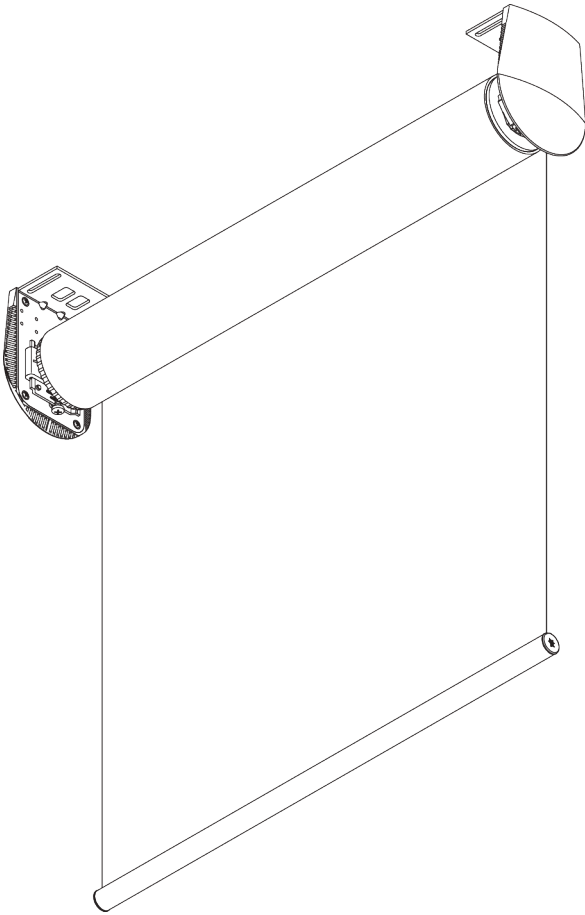
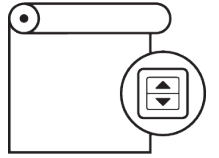

## PRODUKTINFORMATIONEN

- **Bedienung:** Motor
- **Grösse:** L
- **Montage:** Decke, Wand, Nische
- **Farben:** weiss RAL 9016 oder Aluminium farblos eloxiert, Sonderfarben möglich
- **Stoffe:** siehe Silent Gliss Stoffkollektion

### **Merkmale:**

- Leise und schnelle Motoren
- Soft-Stop
- Vielfältige Steuerungsmöglichkeiten
- Einstellbare Edelstahl-Träger zur vertikalen Ausrichtung des Stoffs

# SYSTEMSPEZIFIKATIONEN

## A. MASSE / GEWICHT

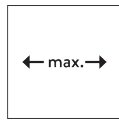

Rohr SG 4901: 4 m  
Rohr SG 4957: 5 m



72 cm\*  
\*siehe  
Motorspezifikationstabelle

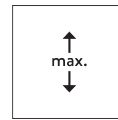

Rohr SG 4901: 12 m  
Rohr SG 4957: 9 m



36 m<sup>2</sup>



23 kg

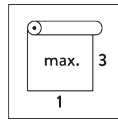

Empfohlenes Breiten- /  
Höhenverhältnis  
max. 1:3

## Maximale Anlagenfläche

B ↓	A →							
	2 m	2.5 m	3 m	3.5 m	4 m	4.5 m	5 m	
2 m	●	●	●	●	○	○	○	
2.5 m	●	●	●	●	○	○	○	
3 m	●	●	●	●	○	○	○	
3.5 m	●	●	●	●	○	○	○	
4 m	●	●	●	●	○	○	○	
4.5 m	●	●	●	●	○	○	○	
5 m	●	●	●	●	○	○	○	
5.5 m	●	●	●	●	○	○	○	
6 m	●	●	●	●	○	○	○	
6.5 m	●	●	●	●	○	○	○	
7 m	●	●	●	●	○	○	○	
7.5 m	●	●	●	●	○	○		
8 m	●	●	●	●	○	○		
8.5 m	●	●	●	●	○			
9 m	●	●	●	●	○			
9.5 m	●	●	●	●				
10 m	●	●	●	●				
10.5 m	●	●	●					
11 m	●	●	●					
11.5 m	●	●	●	max. 36 m <sup>2</sup>				
12 m	●	●	●					

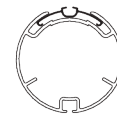

● SG 4901 (ø 80 mm)

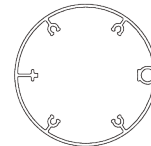

○ SG 4957 (ø 110 mm)

## B. PROFIL

### Profilinformationen

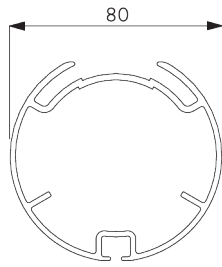

**SG 4901**

Rohr ø 80 mm

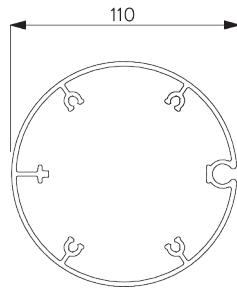

**SG 4957**

Rohr ø 110 mm

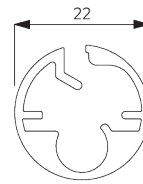

**SG 10760**

Beschwerung

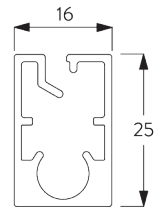

**SG 10770**

Beschwerung

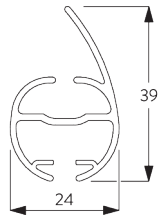

**SG 4903**

Beschwerung

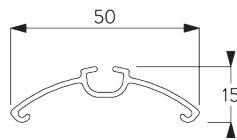

**SG 4902**

Profil

## C. MASSAUFNAHME

inkl. Trägerabdeckung  
(15 mm)

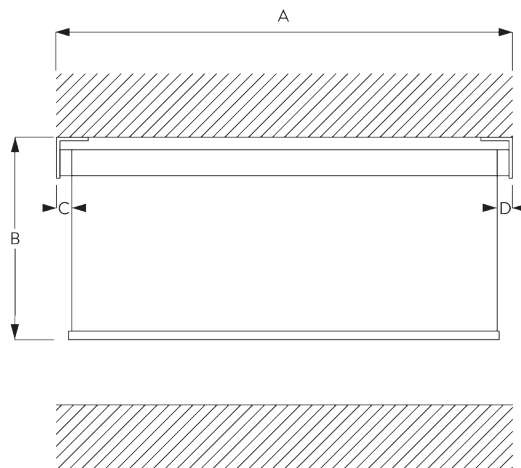

A: Systembreite

B: Systemhöhe

Rohr SG 4901 (ø 80 mm):

C: Lichtspalt: 44 mm

D: Lichtspalt Antriebsseite: 50 mm

Rohr SG 4957 (ø 110 mm):

C: Lichtspalt: 42 mm

D: Lichtspalt Antriebsseite: 52 mm

Bemerkung:

Unterschiedliche Lichtspalte siehe Motorspezifikationen.  
Alle Masse beinhalten 15 mm für die Trägerabdeckung pro Seite!

# MONTAGE

## A. MONTAGE- INFORMATIONEN

Detaillierte Montageinformationen siehe  
Silent Gliss Website.

### Montagepunkte



\*30 mm ohne Abdeckung

\*43 mm mit Abdeckung

**Einstellbare Träger  
(für vertikale  
Ausrichtung)**

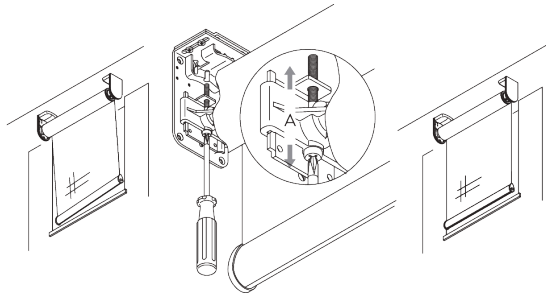

Vertikale Ausrichtung des Stoffes an den Fensterrahmen.

**B. DECKEN-  
MONTAGE**

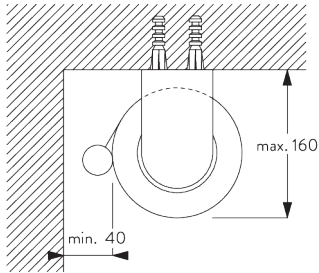

Rohr SG 4901 (ø 80 mm)

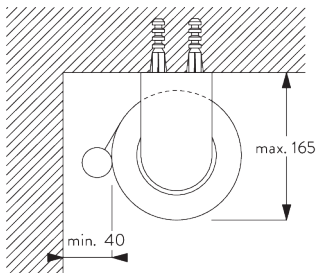

Rohr SG 4957 (ø 110 mm)

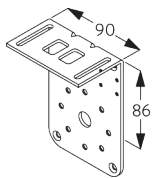

**SG 4904**  
Träger (Set SG 4949)

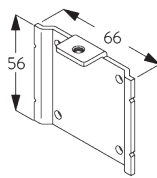

**SG 4906**  
Platte (Set SG 4949)

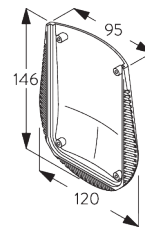

**SG 4956**  
Trägerabdeckung

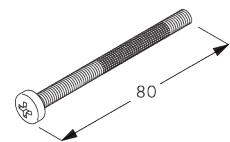

**SG 4966**  
Spezialschraube (Set  
SG 4949)

## C. WANDMONTAGE

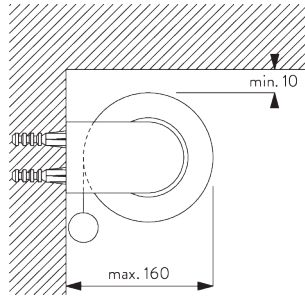

Rohr SG 4901 (ø 80 mm)

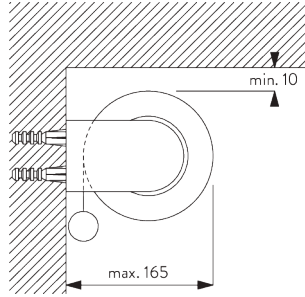

Rohr SG 4957 (ø 110 mm)

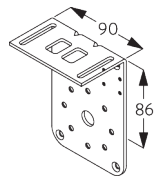

**SG 4904**  
Träger (Set SG 4949)

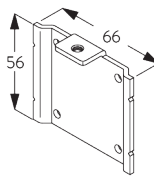

**SG 4906**  
Platte (Set SG 4949)

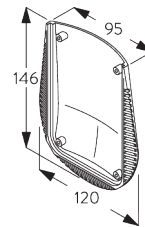

**SG 4956**  
Trägerabdeckung

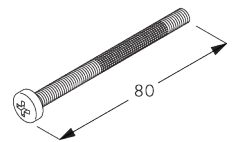

**SG 4966**  
Spezialschraube (Set SG 4949)

## D. NISCHEN- MONTAGE

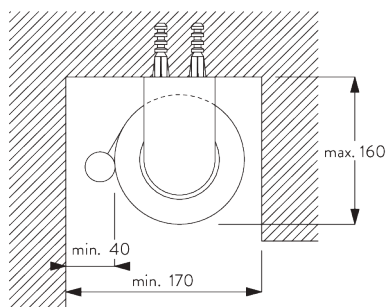

Rohr SG 4901 (ø 80 mm)

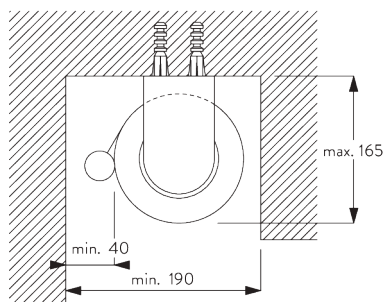

Rohr SG 4957 (ø 110 mm)

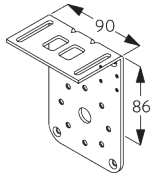

**SG 4904**  
Träger (Set SG 4949)

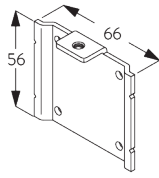

**SG 4906**  
Platte (Set SG 4949)

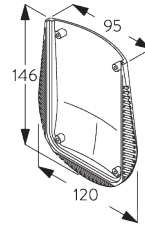

**SG 4956**  
Trägerabdeckung

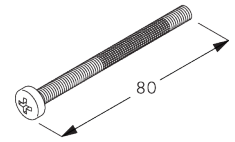

**SG 4966**  
Spezierschraube (Set SG 4949)

## E. SEITLICHE VERSPANNUNG

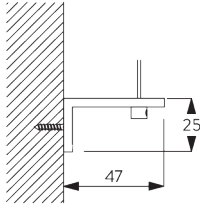

**SG 3036**  
Winkel 47 mm

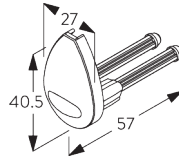
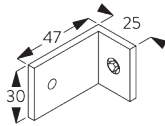

**SG 4944**  
Enddeckel

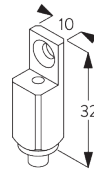

**SG 4946**  
Drahtseilclip

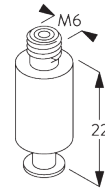

**SG 4947**  
Drahtseilclip

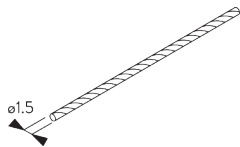

**SG 4948**  
Draht Seitenführung ø 1.5 mm

# SYSTEMOPTIONEN

## A. ABROLL- RICHTUNG

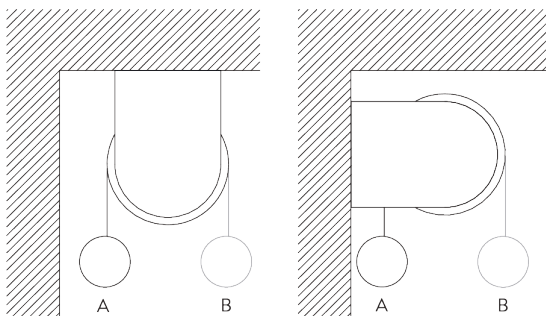

A: Fensterseitiges Stoffabrollen (Standard)  
B: Raumseitiges Stoffabrollen (Option)

## **B. SEITLICHE VERSANNUNG**

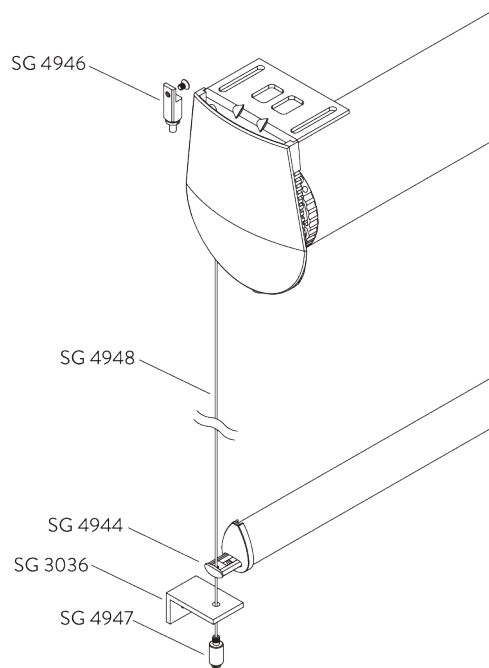

### Zubehör:

- 2x SG 3036 Winkel 47 mm
- 2x SG 4944 Enddeckel Seitenführung
- 2x SG 4946 Drahtseilclip
- 2x SG 4947 Drahtseilclip
- 2x SG 4948 Draht Seitenführung  $\varnothing$  1.5 mm

### Bemerkung:

- Bei Verspannung vergrößert sich der Lichtspalt
- Bis 15° Neigung von der Vertikalen

## **C. MONTAGE- PLATTEN**

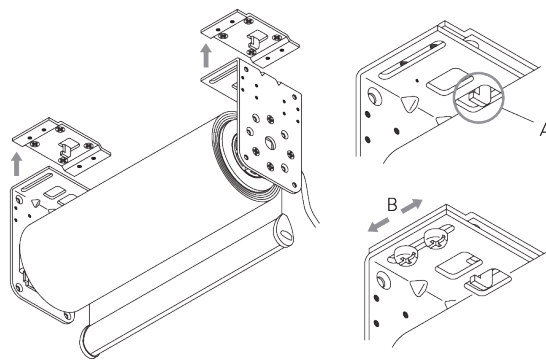

A: Montageplatten SG 4972 tragen das Gewicht des Systems

B: Träger können seitlich bis zu 18 mm verstellt werden

# MOTOREN UND BEDIENUNGSARTEN

## A. MOTOREN- MERKMALE

Motoren	50-Serie	20-Serie	20-Serie
		SG 11255	SG 10327

### Motoreigenschaften

Soft-Stop	•	•	•
Elektronische Endposition	•	•	•
Elektronischer Umdrehungszähler (Umdrehungszahl unbegrenzt)	•	•	•
Zwei Zwischenpositionen möglich		•	
Ausrichtung der Beschwerungsprofile	•		
Geräuschloser Stopp		•	•
Parallelschaltung möglich ohne zusätzliche Relais		•	•
Anschlusskabel an Motor ansteckbar	•	•	•
IP Klasse	IP 30	IP 44	IP 44

### Steuerungsmöglichkeiten

Netzstrom			•
SG Control L (eingebauter Funkempfänger)		•	
Smart by Silent Gliss	•		
Geeignet für alle gängigen Hausautomationssysteme (mit passender Schnittstelle)		•	•

## B. MOTOREN- SPEZIFIKATIONEN

Siehe Website für  
Schaltschema.

### Rohr SG 4901

Motoren	Lichtspalte C / D = Antriebsseite	Min. System- breite	Spannung	Stromstärke	Frequenz	Drehzahl	Funkfrequenz Empfänger
<b>50-Serie (Smart by Silent Gliss)</b>							
SG 11255	C: 44 mm / D: 51 mm	74 cm	24 V DC	2,95 A	-	20 U/Min	-
<b>20-Serie</b>							
SG 10326 (Standard)	C: 44 mm / D: 50 mm	72 cm	230 V AC	0,9 A	50 Hz	23 U/Min	-
SG 10327	C: 44 mm / D: 50 mm	72 cm	230 V AC	0,9 A	50 Hz	23 U/Min	868/915 MHz

Siehe Website für  
Schaltschema.

### Rohr SG 4957

Motoren	Lichtspalte C / D = Antriebsseite	Min. System- breite	Spannung	Stromstärke	Frequenz	Drehzahl	Funkfrequenz Empfänger
<b>50-Serie (Smart by Silent Gliss)</b>							
SG 11255	C: 42 mm / D: 54 mm	74 cm	24 V DC	2,95 A	-	20 U/Min	-
<b>20-Serie</b>							
SG 10326 (Standard)	C: 42 mm / D: 52 mm	73 cm	230 V AC	0,9 A	50 Hz	23 U/Min	-
SG 10327	C: 42 mm / D: 52 mm	73 cm	230 V AC	0,9 A	50 Hz	23 U/Min	868/915 MHz

## C. BEDIENUNGS- ARTEN

Siehe Katalog "Steuerungen" für mehr Details.



**Wandschalter**



*Bedienbar mit drahtgebundenem Wandschalter.*

**SG Control L**



*Verschiedene Funkfernsteuerungen erhältlich.*



*Silent Gliss Move App.*

**Smart by Silent Gliss**



*Offenes Zwei-Weg-Kommunikationssystem, das eine problemlose Integration der Produkte mit den meisten gängigen Gebäudemanagementsystemen ermöglicht.*

**D. SCHALTSCHEMA**



*Siehe Silent Gliss Website.*

# KOMPONENTEN

## A. STANDARD KOMPONENTEN

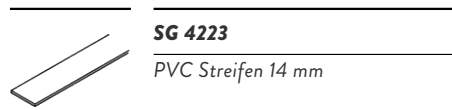

**SG 4223**  
PVC Streifen 14 mm

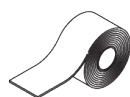

**SG 4226**  
Doppelklebeband 30 mm



**SG 4901**  
Rohr  $\varnothing$  80 mm



**SG 4902**  
Profil

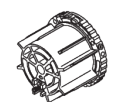

**SG 4914**  
Rohr Adapter

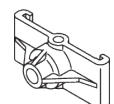

**SG 4915**  
Abstützung



**SG 4926**  
Motorenlager

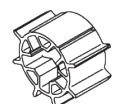

**SG 4927**  
Adapter

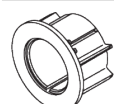

**SG 4928**  
Rohradapter

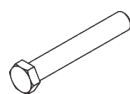

**SG 4939**  
Achse

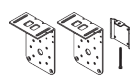

**SG 4949**  
Trägerset



**SG 4956**  
Trägerabdeckung

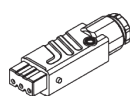

**SG 9917**  
Hirschmann Kupplung STAK 3 N

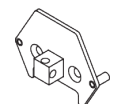

**SG 10285**  
Adapter Platte 10x10 Typ M inkl. Schraube

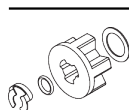

**SG 10292**  
Adapter Set



**SG 10326**  
Motor 230V AC, 20er Serie M 15/23

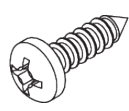

**SG 10503**  
Linsenschraube 3.5x13

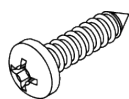

**SG 10506**  
Linsenschraube 3.9x16



**SG 10507**  
Linsenschraube 3.5x6.5

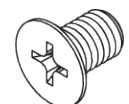

**SG 10509**  
Senkschraube M5x8



**SG 10760**  
Beschwerung



**SG 10761**  
Enddeckel

## B. OPTIONALE KOMPONENTEN

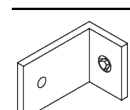

**SG 3036**  
Winkel 47 mm



**SG 4903**  
Beschwerung

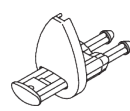

**SG 4944**  
Enddeckel

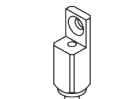

**SG 4946**  
Drahtseilclip

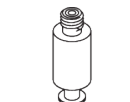

**SG 4947**  
Drahtseilclip



**SG 4948**  
Draht Seitenführung  $\varnothing$  1.5 mm

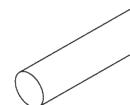

**SG 4951**  
Beschwerung  $\varnothing$  8 mm



**SG 4957**  
Rohr  $\varnothing$  110 mm

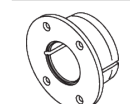

**SG 4959**  
Rohradapter

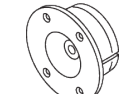

**SG 4961**  
Rohr Adapter



**SG 4962**  
Adapter

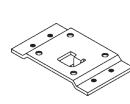

**SG 4972**  
Montageplatte

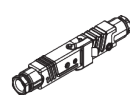

**SG 9916**  
Hirschmann Kupplungsset

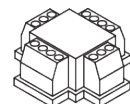

**SG 9959**  
Trennrelais

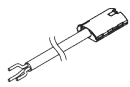
**SG 10293**

Anschlusskabel 230V AC, 2/3/5/10 m

**SG 10300**

Funkhandsender 1-Kanal

**SG 10302**

Funkhandsender 5+1-Kanal

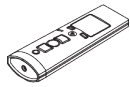
**SG 10303**

Funkhandsender 10+2+1-Kanal

**SG 10327**

Motor 230V AC, 20er Serie M 15/23, Funkempfänger

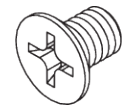
**SG 10502**

Senkschraube M4x6

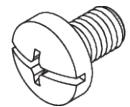
**SG 10504**

Linsenschraube Freedrive M5x8

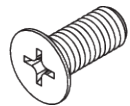
**SG 10508**

Senkschraube M5x12

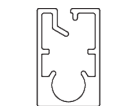
**SG 10770**

Beschwerung

**SG 10771**

Enddeckel

**SG 10804**

Funkhandsender 15+5+1 Kanal

**SG 11178**

Enddeckel

**SG 11255**

Motor 24V DC, 50-Serie M 10/20

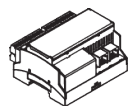
**SG 11260**

Gateway Cedia

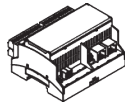
**SG 11261**

Gateway KNX

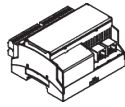
**SG 11262**

Erweiterung

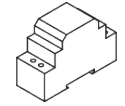
**SG 11263**

Transformer 24V DC, 2.5 Ampere DIN Rail

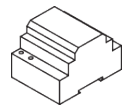
**SG 11264**

Transformer 24V DC, 3.8 Ampere DIN Rail

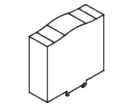
**SG 11265**

Transformer 24V DC, 5 Ampere DIN Rail

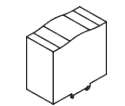
**SG 11266**

Transformer 24V DC, 10 Ampere DIN Rail

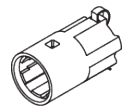
**SG 11321**

Mitnehmer

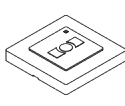
**SG 11480**

Funkwandsender 1-Kanal

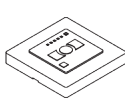
**SG 11490**

Funkwandsender 5+1-Kanal

