

SG 2090

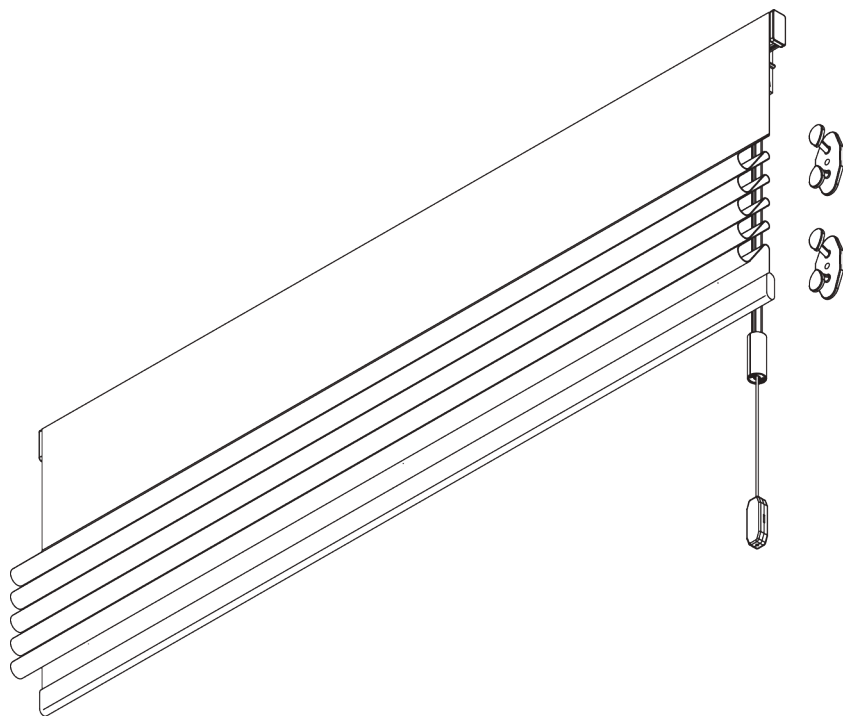
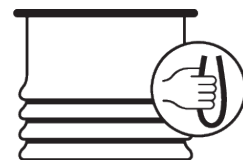

PRODUKTINFORMATIONEN

- **Bedienung:** Schnur
- **Grösse:** S
- **Montage:** Wand
- **Farben:** weiss RAL 9016
- **Stoffe:** siehe Silent Gliss Stoffkollektion

Merkmale:

- Einfache Montage am Fensterflügel

SYSTEMSPEZIFIKATIONEN

A. MASSE / GEWICHT



1 m

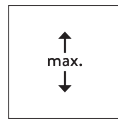

2 m



0.7 kg



2 m²

B. PROFIL

Profilinformationen

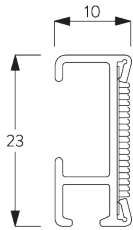

SG 2116

Velcroprofil

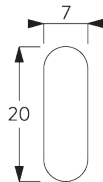

SG 2004

Beschwerung 20x7 mm

C. MASSAUFNAHME

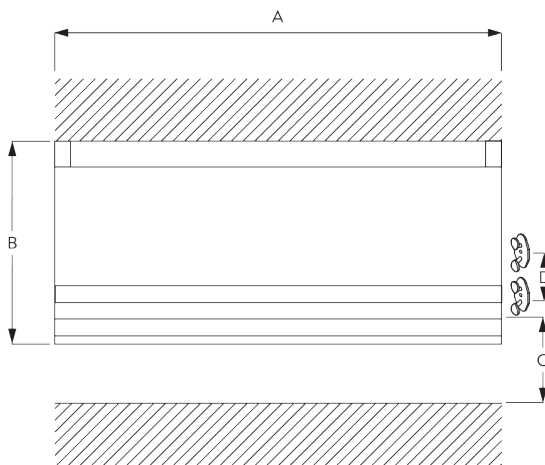

A: Systembreite

B: Systemhöhe

C: Schnuraufwickler SG 10742 min. 150 cm über Boden

D: 7 - 35 cm je nach Systemhöhe

MONTAGE

A. MONTAGE- INFORMATIONEN

Detaillierte Montageinformationen siehe
Silent Gliss Website

Montagepunkte

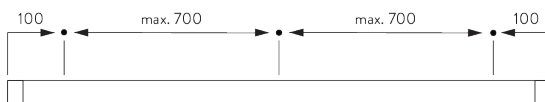

B. WANDMONTAGE

Clip SG 3666

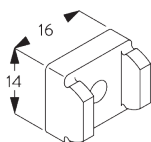
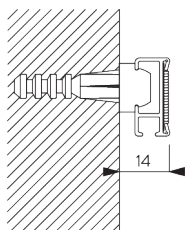

SG 3666

Träger

SYSTEMOPTIONEN

A. KONFEKTIONS- ARTEN

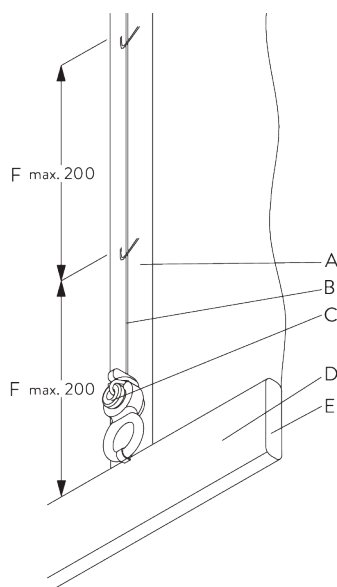

A: Laschenband SG 3074

B: Kordel SG 2216

C: Kindersicherheit Befestigungsset SG 3167









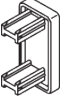

D: Hohlraum

E: Beschwerung SG 2004

F: Kindersicherheit: Distanz max. 200 mm

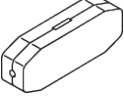
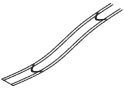
KOMPONENTEN

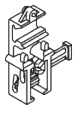
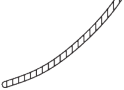
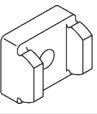
A. STANDARD KOMPONENTEN

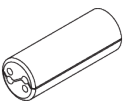
	SG 2004 Beschwerung 20x7 mm
	SG 2116 Velcroprofil
	SG 2131 Enddeckel
	SG 2215 Öse
	SG 2216 Schnur ø 0.85 mm
	SG 2539 Flauschband
	SG 2826 Kordelverbinder (2 x)
	SG 3074 Laschenband
	SG 3167 Kindersicherheitsklemmenset
	SG 3185 Schnurarretierung
	SG 3637 Kordel
	SG 3666 Träger
	SG 10742 Kindersicherheit Schnuraufwickler
	SG 10745 Kindersicherheit Schnurverbinder

B. OPTIONALE KOMPONENTEN

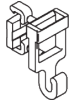
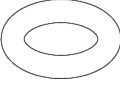
	SG 3055 Haken
	SG 11482 Ring