

# SG 8600

---

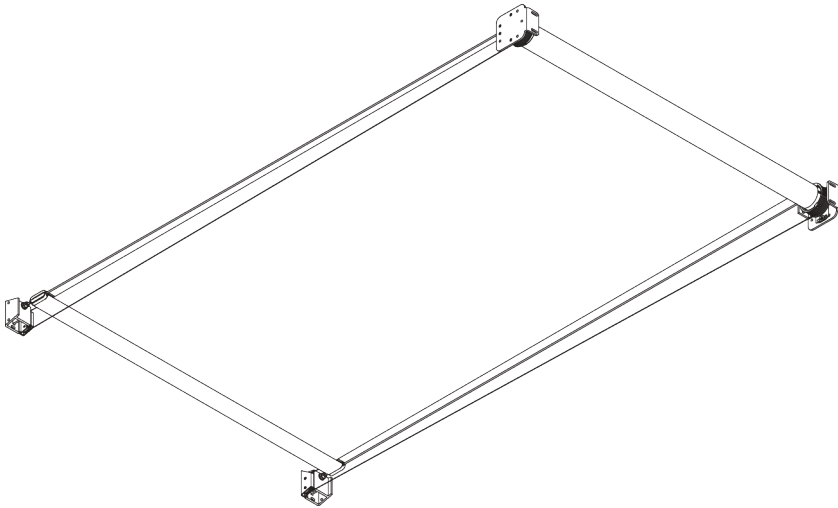

## PRODUKTINFORMATIONEN

- **Bedienung:** Motor
- **Grösse:** M - L
- **Montage:** Aufmontage, Untermontage
- **Farben:** weiss RAL 9016, Sonderfarben möglich
- **Stoffe:** siehe Silent Gliss Stoffkollektion

### **Merkmale:**

- Gegenzuganlage
- Vielfältige Steuerungsmöglichkeiten
- 360° einsetzbar

# SYSTEMSPEZIFIKATIONEN

## A. MASSE / GEWICHT



4 m



M: 87 cm  
L: 108 cm



M: 3 m  
L: 6.5 m



18 m<sup>2</sup>

## B. PROFIL

### Profilinformationen

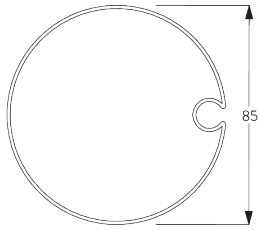

SG 8601

Rohr ø 85 mm

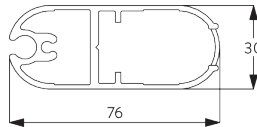

SG 8602

Profil

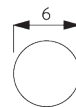

SG 8618

Stoffkeder ø 6 mm

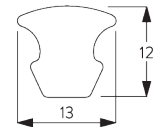

SG 8626

Abdeckstreifen

## C. MASSAUFNAHME

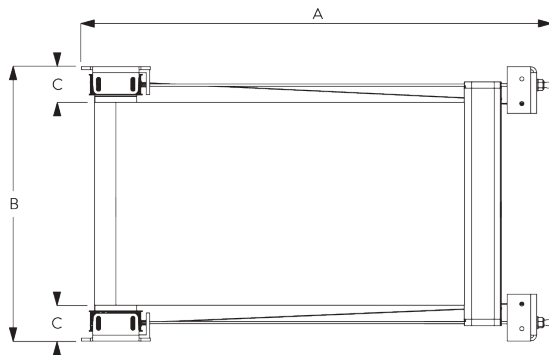

A: Systemlänge

B: Systembreite

C: Lichtspalt: 75 mm

Zugkraft pro Träger: ca. 100 kg

# MONTAGE

## A. MONTAGE- INFORMATIONEN

Detaillierte Montageinformationen siehe  
Silent Gliss Website

## B. AUFMONTAGE

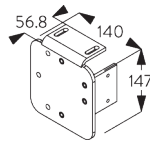
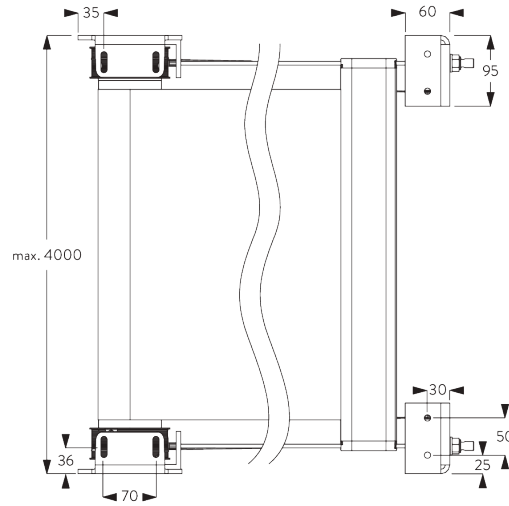
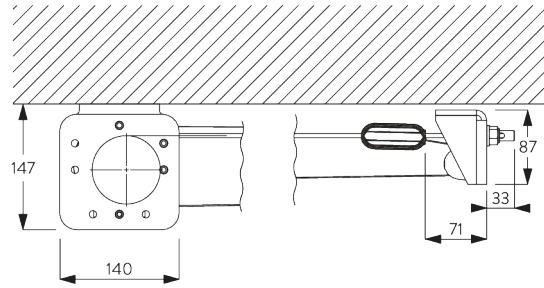

**SG 8606**  
Rollenträger Decke links

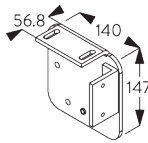

**SG 8607**  
Rollenträger Decke rechts

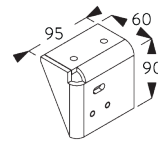

**SG 8608**  
Umlenkung Decke links

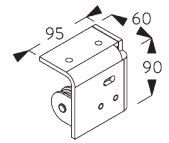

**SG 8609**  
Umlenkung Decke rechts

## C. UNTERMONTAGE

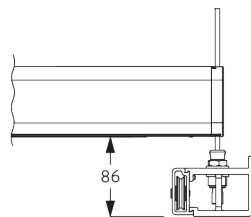
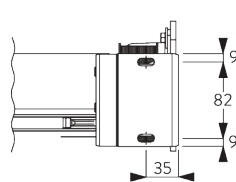
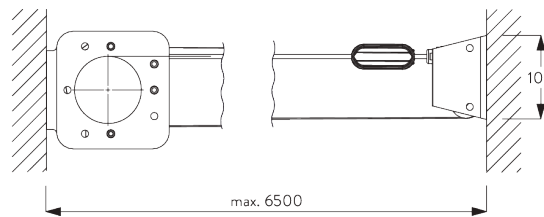

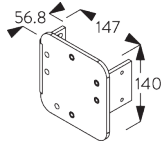

**SG 8611**  
Rollenträger Wand links

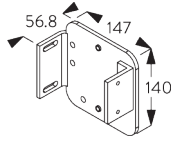

**SG 8612**  
Rollenträger Wand rechts

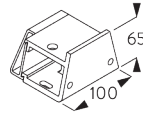

**SG 8621**  
Umlenkung Seite/Rückwand links

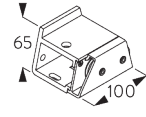

**SG 8622**  
Umlenkung Seite/Rückwand rechts

# MOTOREN UND BEDIENUNGSARTEN

## A. MOTOREN- MERKMALE

Motor	SG 8605
<b>Motoreigenschaften</b>	
Mechanischer Endstopp	•
Mechanischer Umdrehungszähler (Umdrehungszahl begrenzt)	•
IP Klasse	IP 44
<b>Steuerungsmöglichkeiten</b>	
Netzstrom	•
SG Control L (externer Funkempfänger erforderlich)	•
Geeignet für alle gängigen Hausautomationssysteme (mit passender Schnittstelle)	•

## B. MOTOREN- SPEZIFIKATIONEN

Motor	Spannung	Stromstärke	Frequenz	Drehzahl
SG 8605	230 V AC	0.65 A	50 Hz	17 U/Min

Siehe Website für  
Schaltschema.

## C. BEDIENUNGS- ARTEN

Siehe Katalog "Steuerungen" für mehr Details.

Wandschalter



Bedienbar mit drahtgebundenem Wandschalter.

SG Control L



Verschiedene Funkfernsteuerungen erhältlich.  
Ein externer Empfänger wird benötigt.



*Silent Gliss Move App.*

**D. SCHALTSHEMA**



*Siehe Silent Gliss Website.*

# KOMPONENTEN

## A. STANDARD KOMPONENTEN



**SG 8601**

Rohr ø 85 mm



**SG 8602**

Profil

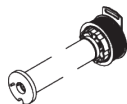

**SG 8604**

Feder lang

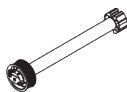

**SG 8605**

Motor 230V AC

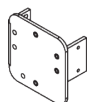

**SG 8611**

Rollenträger Wand links

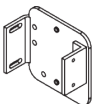

**SG 8612**

Rollenträger Wand rechts

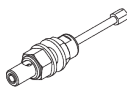

**SG 8616**

Spannseil Set



**SG 8618**

Stoffkeder ø 6 mm

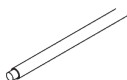

**SG 8619**

Zuglitze ø 1.5 mm

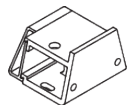

**SG 8621**

Umlenkung Seite/Rückwand links

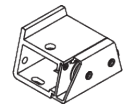

**SG 8622**

Umlenkung Seite/Rückwand rechts

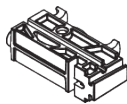

**SG 8623**

Beschwerungshalter

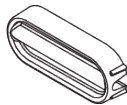

**SG 8624**

Enddeckel

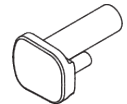

**SG 8625**

Stoffsicherung



**SG 8626**

Abdeckstreifen

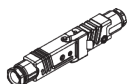

**SG 9916**

Hirschmann Kupplungsset

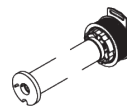

**SG 8603**

Feder kurz



**SG 8606**

Rollenträger Decke links

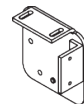

**SG 8607**

Rollenträger Decke rechts



**SG 8608**

Umlenkung Decke links

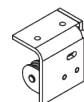

**SG 8609**

Umlenkung Decke rechts

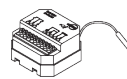

**SG 9068**

Funkempfänger Revio P



**SG 9945**

Funkempfänger 1 Kanal 230V

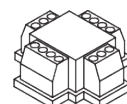

**SG 9959**

Trennrelais



**SG 10300**

Funkhandsender 1-Kanal



**SG 10302**

Funkhandsender 5+1-Kanal

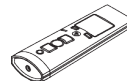

**SG 10303**

Funkhandsender 10+2+1-Kanal

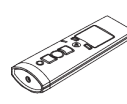

**SG 10804**

Funkhandsender 15+5+1 Kanal



**SG 11480**

Funkwandsender 1-Kanal

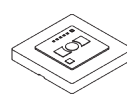

**SG 11490**

Funkwandsender 5+1-Kanal



