

SG 1014

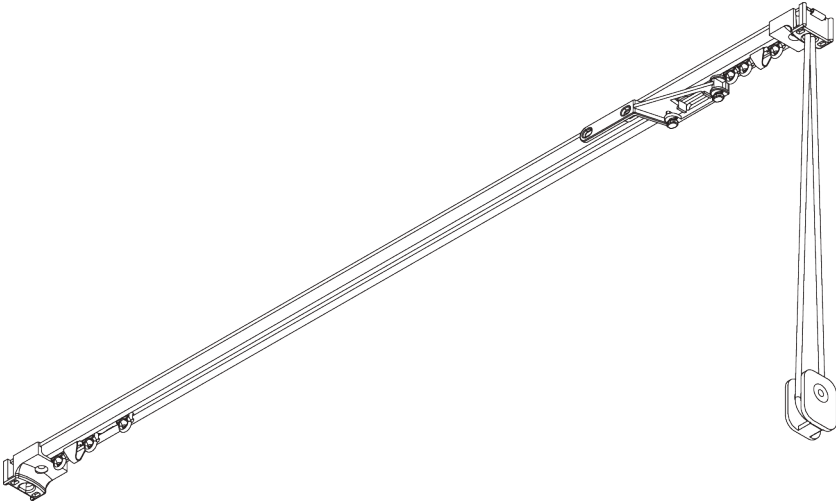
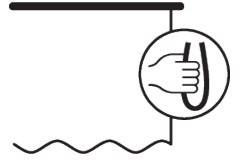

PRODUCT INFORMATION

- **Operation:** cord
- **Range:** S
- **Fitting:** ceiling
- **Colours:** white RAL 9016 or anodised aluminum, special colours possible
- **Fabrics:** refer to Silent Gliss fabric collection

Features:

- Pre-drilled profile
- Bendable
- Fitting tool center SG 7550

SYSTEM SPECIFICATIONS

A. SYSTEM DIMENSIONS



6 m



11 kg

Max. curtain weight

	2 m	4 m	6 m
	8	7	6
	11	10	8
	5	4	-
	6	5	-
	3	2	-
	5	4	-
	(kg max.)		

B. PROFILE

Profile and bending information

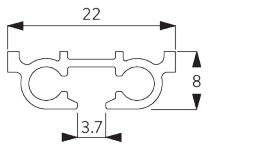

SG 1014p

Profile



C. HOW TO MEASURE

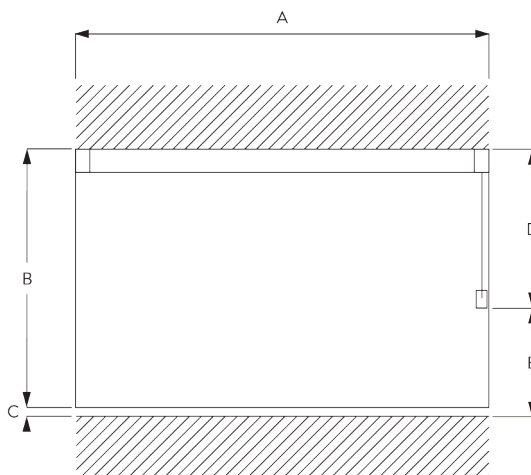

A: System width

B: System height

C: Distance between floor and fabric

D: Cord height

E: Safety Retainer SG 10731 min. 150 cm above floor

FITTING

A. FITTING INFORMATION

For detailed fitting information, visit the Silent Gliss website.

Fixing points

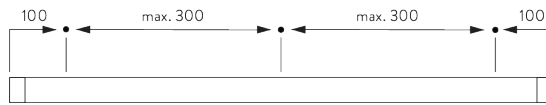

Fitting Tool

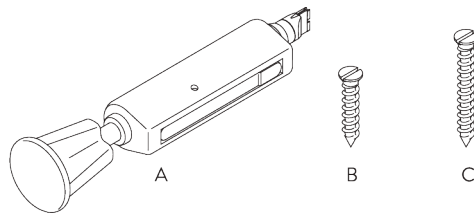

A: Center SG 7550 Tool
 B: Special Screw SG 3019 / 12 mm
 C: Special Screw SG 3025 / 18 mm

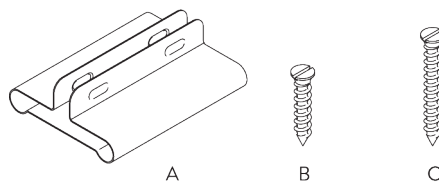

A: Profile Protector SG 7002
 B: Special Screw SG 3019 / 12 mm
 C: Special Screw SG 3025 / 18 mm

B. CEILING FITTING

Direct into wood

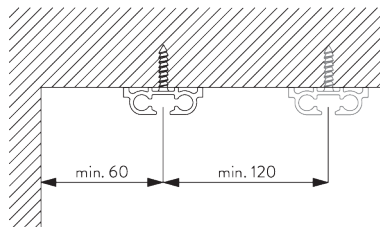



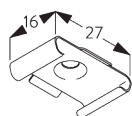
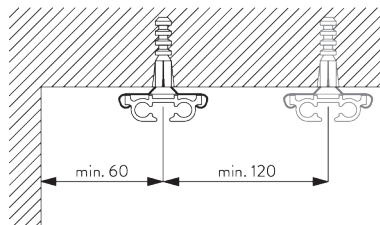



Bracket SG 3114

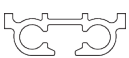
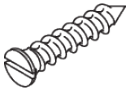
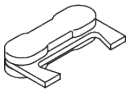

SG 3114
 Bracket

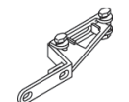

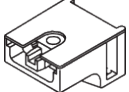
PARTS

A. STANDARD PARTS

	SG 1014p Profile
	SG 3019 Special screw 12 mm
	SG 3030 Pilot runner
	SG 3085 Spring stop
	SG 3090 Cord ø 3.5 mm
	SG 3242 Overlap arm
	SG 3533 Glider
	SG 3599 Hook
	SG 3714 Cord guide
	SG 10731 Child safety retainer set

B. OPTIONAL PARTS

	SG 3012 Hook
	SG 3025 Special screw 18 mm
	SG 3045 Overlap arm
	SG 3070 End stop
	SG 3091 Cord ø 3.5 mm
	SG 3114 Bracket
	SG 3340 Cord/chain weight
	SG 3511 Glider
	SG 3534 Glider 3533 on strip
	SG 3535 Glider
	SG 3537 Glider
	SG 3547 Glider
	SG 3548 Glider
	SG 3549 Click glider with hook

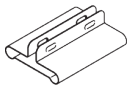
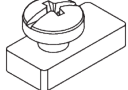
	SG 3582 Hook
	SG 3598 Eyelet
	SG 3735 Cord weight with tensioner
	SG 7002 Profile protector
	SG 11335 End stop