

SG 3840

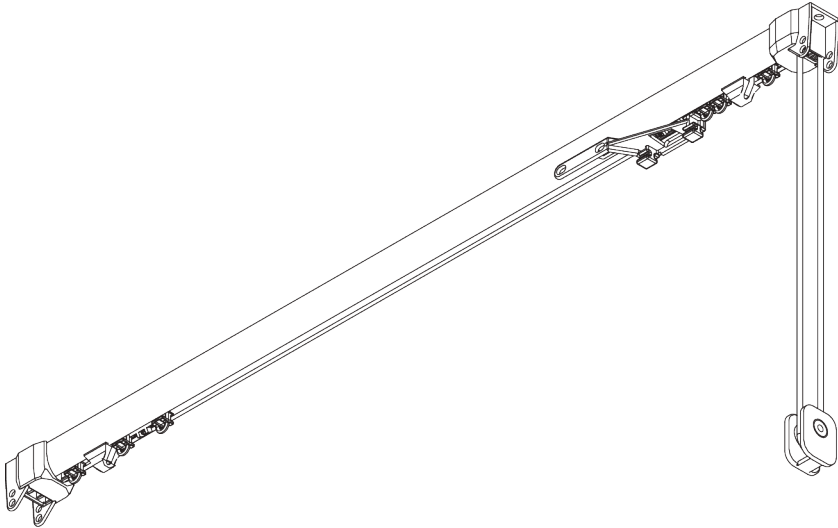

PRODUCT INFORMATION

- **Operation:** cord
- **Range:** M - L
- **Fitting:** ceiling, wall
- **Colours:** white RAL 9016, black RAL 9005 or anodised aluminum, special colours possible
- **Fabrics:** refer to Silent Gliss fabric collection

Features:

- 2-component (2C) glider technology
- Wave (2C)
- Bendable

SYSTEM SPECIFICATIONS

A. SYSTEM DIMENSIONS



6 m

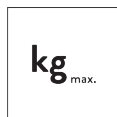

14 kg

Max. curtain weight - 2C glider or roller

| | 2 m | 4 m | 6 m |
|--|-----|-----|-----|
| | 12 | 11 | 10 |
| | 14 | 13 | 12 |
| | 9 | 8 | 7 |
| | 10 | 9 | 6 |
| | 6 | 5 | 4 |
| | 7 | 6 | 5 |
| | 5 | 4 | 3 |
| | 6 | 5 | 4 |

(kg max.)

Max. curtain weight - Wave 2C glider cord

| | 2 m | 4 m | 6 m |
|--|-----|-----|-----|
| | 5 | 8 | 7 |
| | 5 | 8 | 8 |
| | 5 | 6 | 5 |
| | 5 | 6 | 6 |
| | 4 | 3 | - |
| | 4 | 4 | 3 |
| | 3 | 2 | - |
| | 3 | 3 | - |

(kg max.)

B. PROFILE

Profile and bending information

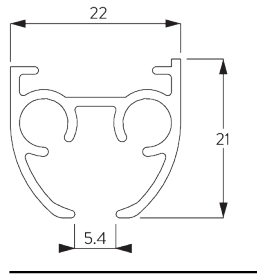

SG 3841

Profile

Radius:
20 cm, >30 cm

C. HOW TO MEASURE

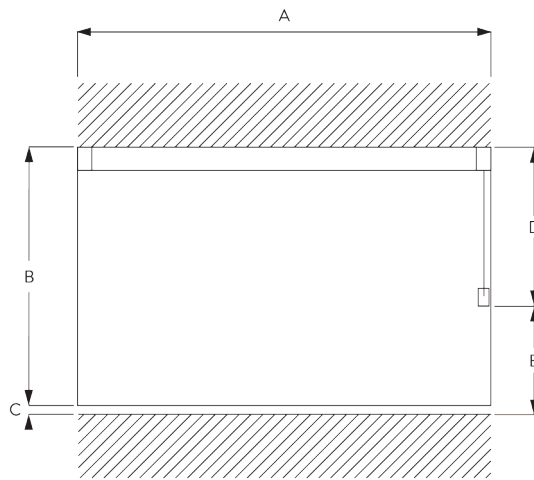

A: System width
B: System height
C: Distance between floor and fabric
D: Cord height
E: Safety Retainer SG 10731 min. 150 cm above floor

FITTING

A. FITTING INFORMATION

For detailed fitting information, visit the [Silent Gliss website](#).

Fixing Points

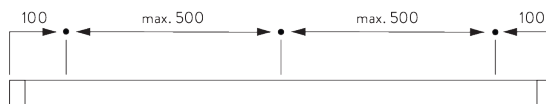

B. CEILING FITTING

Clamp SG 3825

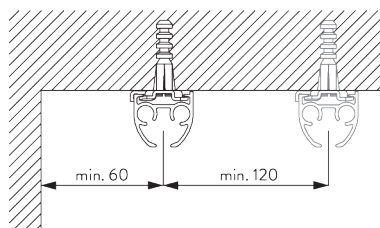

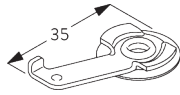

SG 3825

Clamp

Bracket SG 3832

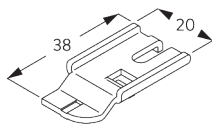
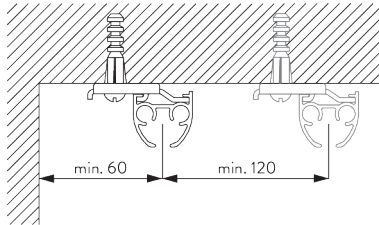

SG 3832

Bracket

Bracket SG 3826

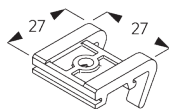
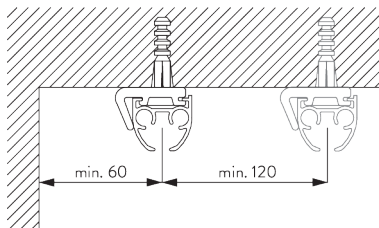

SG 3826

Bracket

C. WALL FITTING

Smart Fix

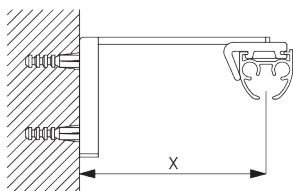

Smart Fix SG 11200 - SG 11205 and bracket SG 3826:
Screw SG 10492 (M4x8) needed.

| Smart Fix | X mm (SG 3826 / SG 3825) | X mm (SG 3832) |
|---------------------|--------------------------|----------------|
| SG 11200 / SG 11210 | 52 | 70 |
| SG 11201 / SG 11211 | 72 | 90 |
| SG 11202 / SG 11212 | 92 | 110 |
| SG 11203 / SG 11213 | 112 | 130 |
| SG 11204 / SG 11214 | 142 | 160 |
| SG 11205 / SG 11215 | 192 | 210 |
| SG 11154 | 102-130 | 120-148 |
| SG 11155 | 132-160 | 150-178 |
| SG 11156 | 182-210 | 200-228 |

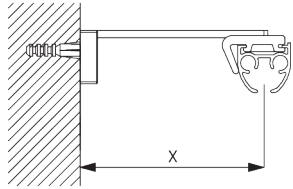

Square Smart Fix SG 11210 - SG 11215 and bracket SG 3826:

Screw SG 10492 (M4x8) needed.

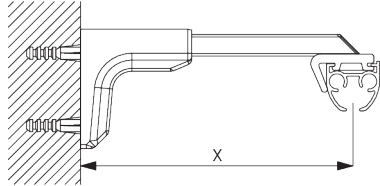

Universal Smart Fix SG 11154 - SG 11156 and bracket SG 3826:

Screw SG 10277 (M4x12) needed.

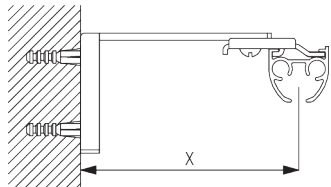

Smart Fix SG 11200 - SG 11205 and bracket SG 3832:

Screw SG 10492 (M4x8) needed.

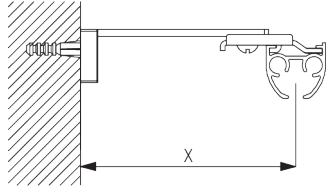

Square Smart Fix SG 11210 - SG 11215 and bracket SG 3832:

Screw SG 10492 (M4x8) needed.

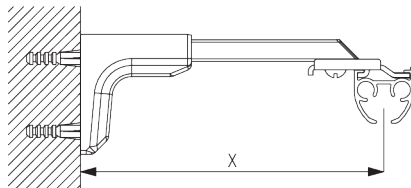

Universal Smart Fix SG 11154 - SG 11156 and bracket SG 3832:

Screw SG 10407 (M4x10) needed.

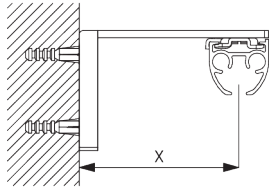

Smart Fix SG 11200 - SG 11205 and clamp SG 3825:
Screw SG 10074 (M4x8) needed.

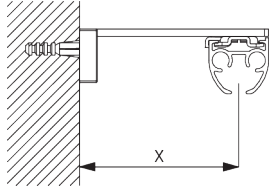

Square Smart Fix SG 11210 - SG 11215 and clamp SG 3825:
Screw SG 10074 (M4x8) needed.

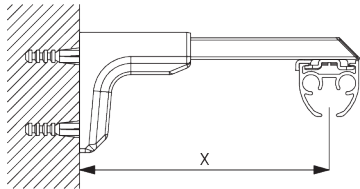

Universal Smart Fix SG 11154 - SG 11156 and clamp SG 3825:
Screw SG 11158 (M4x12) needed.

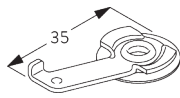

SG 3825
Clamp

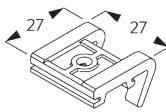

SG 3826
Bracket

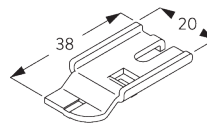

SG 3832
Bracket



SG 10074
Countersunk head screw
M4x8



SG 10277
Pan head screw M4x12



SG 10407
Pan head screw M4x10



SG 10492
Pan head screw M4x8



SG 11158
Countersunk head screw
M4x12

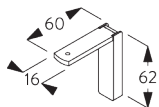

SG 11200
Smart Fix 60 mm

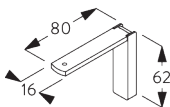

SG 11201
Smart Fix 80 mm

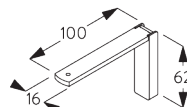

SG 11202
Smart Fix 100 mm

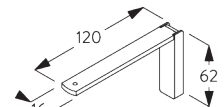

SG 11203
Smart Fix 120 mm

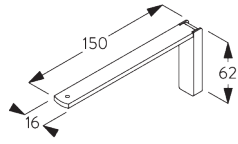

SG 11204
Smart Fix 150 mm

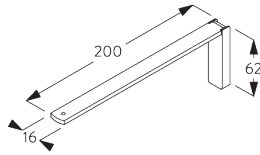

SG 11205
Smart Fix 200 mm

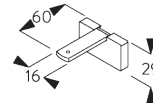

SG 11210
Square Smart Fix 60 mm

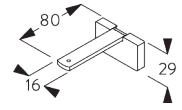

SG 11211
Square Smart Fix 80 mm

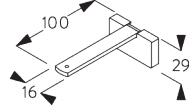

SG 11212
Square Smart Fix 100 mm

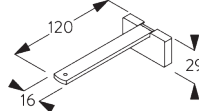

SG 11213
Square Smart Fix 120 mm

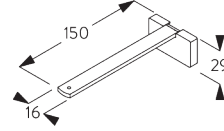

SG 11214
Square Smart Fix 150 mm

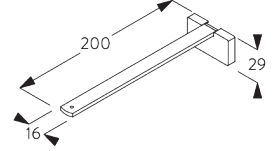

SG 11215
Square Smart Fix 200 mm

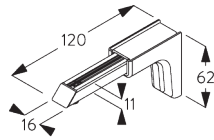

SG 11154
Universal Smart Fix 120 mm

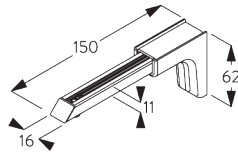

SG 11155
Universal Smart Fix 150 mm

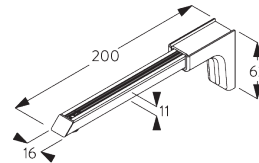

SG 11156
Universal Smart Fix 200 mm

Bracket SG 3836

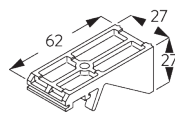
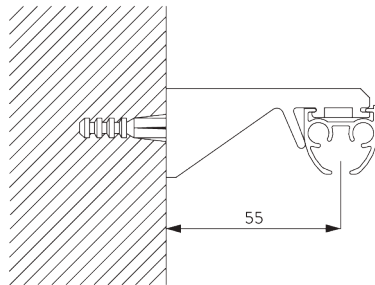

SG 3836
Bracket

SYSTEM OPTIONS

A. WAVE

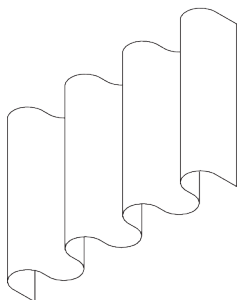

SG 11295

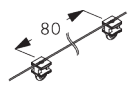

SG 11302

Standard components:

- SG 11295 End stop
- SG 11302 Wave 2C glider cord 80 mm

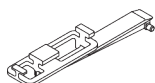

SG 6364



SG 6365

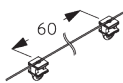

SG 11303

Optional components (min. radius >30 cm):

- SG 6364 Wave extension
- SG 6365 Wave hanger
- SG 11303 Wave 2C glider Cord 60 mm



SG 3582

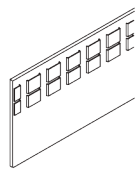

SG 6349

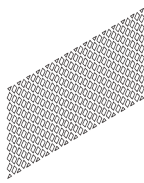

SG 6363

Curtain components:

- SG 3582 Hook
- SG 6349 Wave curtain tape
- SG 6363 Wave top hemming tape
- SG 10075 Lead weight 50 gr/m
- SG 10076 Fabric weight

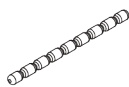

SG 10075



SG 10076

Wave stack depth - 2C glider cord (standard components)

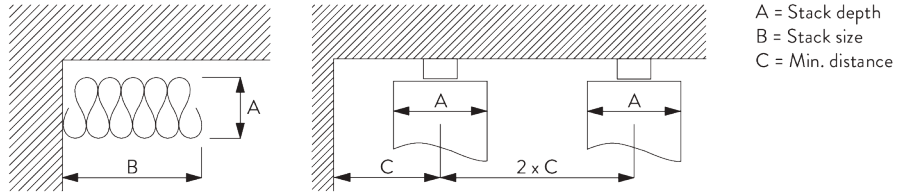

| 2C Glider cord SG 11302 | Pockets between hooks | Approx. curtain fullness | Stack depth A | Stack size B* | Min distance C |
|----------------------------|--------------------------|-----------------------------|------------------|---------------------------|-------------------|
| 80 | 6 | ~2.1 | 140 | 180 per metre of track | 90 |
| 80 | 7 | ~2.3 | 160 | 180 per metre of track | 100 |

| 2C Glider cord SG 11303 | Pockets between hooks | Approx. curtain fullness | Stack depth A | Stack size B* | Min distance C |
|----------------------------|--------------------------|-----------------------------|------------------|---------------------------|-------------------|
| 60 | 4 | ~2.1 | 100 | 230 per metre of track | 70 |
| 60 | 5 | ~2.3 | 120 | 230 per metre of track | 80 |

**Stack size B standard*









- single stack = plus 130 mm per curtain
- pair stack = plus 30 mm per curtain

**Stack size B optional*



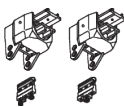
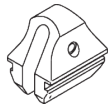









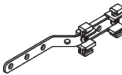

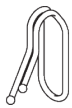
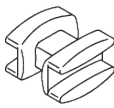

- single stack = plus 200 mm per curtain
- pair stack = plus 200 mm per curtain

PARTS

A. STANDARD PARTS

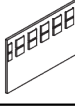
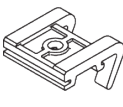
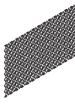
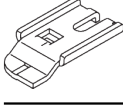
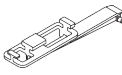
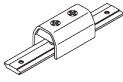
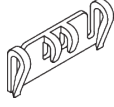
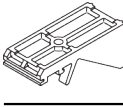
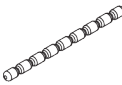
| | |
|--|--|
|  | SG 3090 Cord ø 3.5 mm |
|  | SG 3599 Hook |
|  | SG 3825 Clamp |
|  | SG 3841 Profile |
|  | SG 3845 Cord guide set |
|  | SG 6086 Spring stop |
|  | SG 6288 Overlap arm |
|  | SG 10731 Child safety retainer set |
|  | SG 11300 2C glider |

B. OPTIONAL PARTS

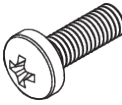
| | | | |
|---|--|---|---|
|  | SG 3012 Hook |  | SG 6057 Glider |
|  | SG 3091 Cord ø 3.5 mm |  | SG 6063 Overlap arm |
|  | SG 3340 Cord/chain weight |  | SG 6065 End stop |
|  | SG 3581 Hook |  | SG 6082 Glider |
|  | SG 3582 Hook |  | SG 6094 Roller |
|  | SG 3598 Eyelet |  | SG 6098 Roller |
|  | SG 3735 Cord weight with tensioner |  | SG 6283 Roller |
|  | SG 3802 Connection bridge |  | SG 6349 Wave curtain tape |
|  | SG 3826 Bracket |  | SG 6363 Wave top hemming tape |
|  | SG 3832 Bracket |  | SG 6364 Wave extension |
|  | SG 3833 Intermediate guide |  | SG 6365 Wave hanger |
|  | SG 3836 Bracket |  | SG 10075 Lead weight 50 g/m |
|  | SG 6004 Eyelet |  | SG 10076 Fabric weight |
|  | SG 6053 Spring stop |  | SG 10277 Pan head screw M4x12 |

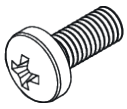

SG 10407
Pan head screw M4x10

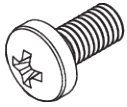

SG 10492
Pan head screw M4x8

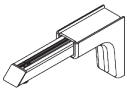

SG 11154
Universal Smart Fix 120 mm

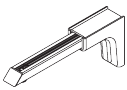

SG 11155
Universal Smart Fix 150 mm

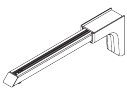

SG 11156
Universal Smart Fix 200 mm

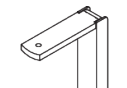

SG 11200
Smart Fix 60 mm

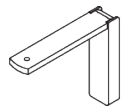

SG 11201
Smart Fix 80 mm

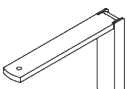

SG 11202
Smart Fix 100 mm

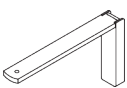

SG 11203
Smart Fix 120 mm

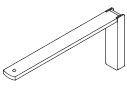

SG 11204
Smart Fix 150 mm

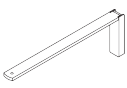

SG 11205
Smart Fix 200 mm

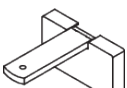

SG 11210
Square Smart Fix 60 mm

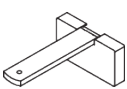

SG 11211
Square Smart Fix 80 mm

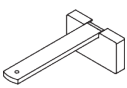

SG 11212
Square Smart Fix 100 mm

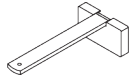

SG 11213
Square Smart Fix 120 mm

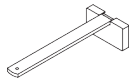

SG 11214
Square Smart Fix 150 mm

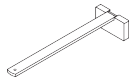

SG 11215
Square Smart Fix 200 mm

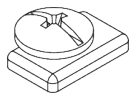

SG 11295
End stop



SG 11301
2C glider on strip

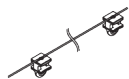

SG 11302
Wave 2C glider cord 80 mm



SG 11303
Wave 2C glider cord 60 mm



SG 11305
2C glider for direct sewing

