

SG 3870

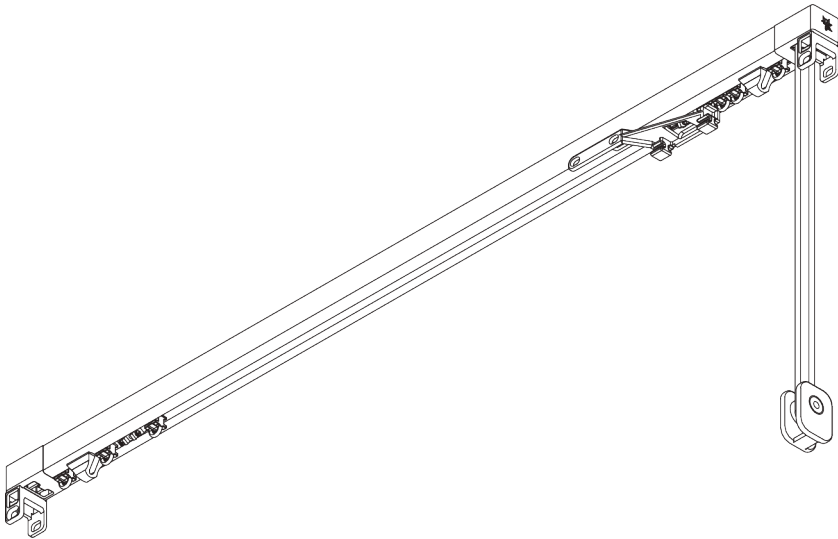
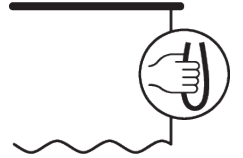

PRODUCT INFORMATION

- **Operation:** cord
- **Range:** M - L
- **Fitting:** ceiling, wall, recess
- **Colours:** white RAL 9016, black RAL 9005 or anodised aluminum, special colours possible (recess profile only in white RAL 9016, black RAL 9005 or special color)
- **Fabrics:** refer to Silent Gliss fabric collection

Features:

- 2-component (2C) glider technology
- Wave (2C)
- Bendable
- Bendable recess profile

SYSTEM SPECIFICATIONS

A. SYSTEM DIMENSIONS

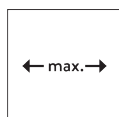

6 m

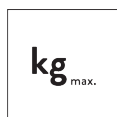

14 kg

Max. curtain weight - 2C glider or roller

	2 m	4 m	6 m
	12	11	10
	14	13	12
	9	8	7
	10	9	6
	6	5	4
	7	6	5
	5	4	3
	6	5	4

(kg max.)

Max. curtain weight - Wave 2C glider cord

	2 m	4 m	6 m
	5	8	7
	5	8	8
	5	6	5
	5	6	6
	4	3	-
	4	4	3
	3	2	-
	3	3	-

(kg max.)

B. PROFILE

Profile and bending information

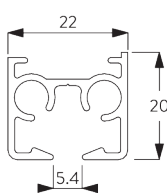

SG 11190

Profile

Radius: >26 cm

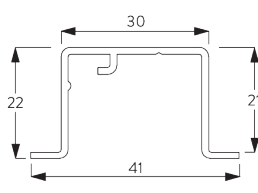

SG 11230

Recess profile

Radius: >50 cm

**C. HOW TO
MEASURE**

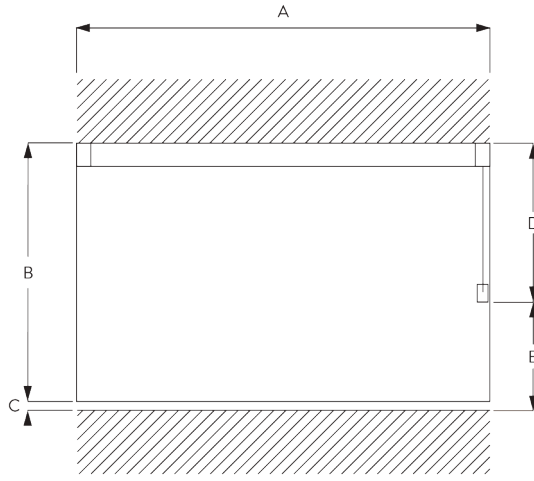

- A: System width
- B: System height
- C: Distance between floor and fabric
- D: Cord height
- E: Safety Retainer SG 10731 min. 150 cm above floor

FITTING

**A. FITTING
INFORMATION**

For detailed fitting information, visit the Silent Gliss website.

Fixing points

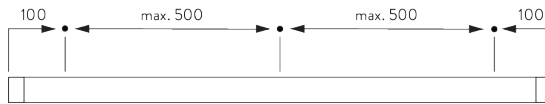

B. CEILING FITTING

Clamp SG 3825

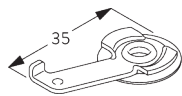
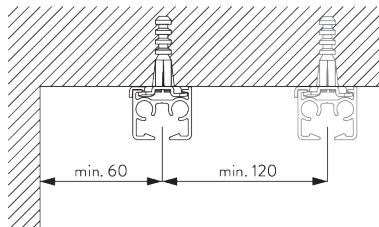

SG 3825
Clamp

Bracket SG 3826

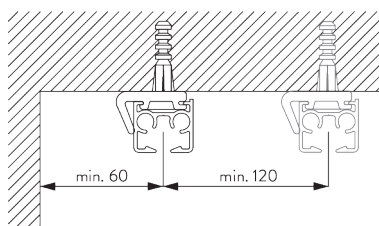

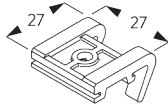

SG 3826
Bracket

Bracket SG 3832

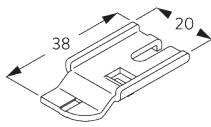
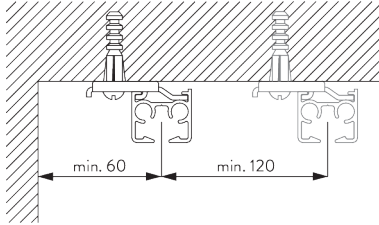

SG 3832
Bracket

C. WALL FITTING

Smart Fix

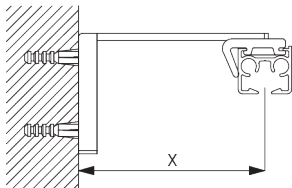

Smart Fix SG 11200 - SG 11205 and bracket SG 3826:
Screw SG 10492 (M4x8) needed.

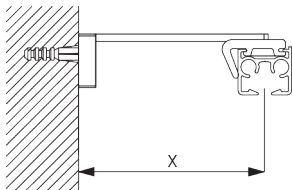

Square Smart Fix SG 11210 - SG 11215 and bracket SG 3826:
Screw SG 10492 (M4x8) needed.

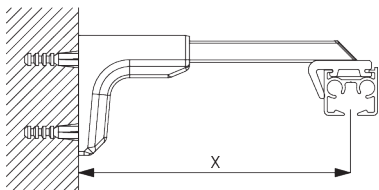

Universal Smart Fix SG 11154 - SG 11156 and bracket SG 3826:
Screw SG 10277 (M4x12) needed.

Smart Fix	X mm (SG 3826 / SG 3825)	X mm (SG 3832)
SG 11200 / SG 11210	52	70
SG 11201 / SG 11211	72	90
SG 11202 / SG 11212	92	110
SG 11203 / SG 11213	112	130
SG 11204 / SG 11214	142	160
SG 11205 / SG 11215	192	210
SG 11154	102-130	120-148
SG 11155	132-160	150-178
SG 11156	182-210	200-228

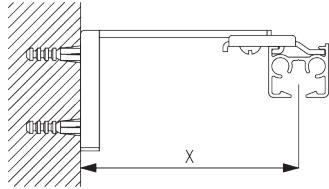

Smart Fix SG 11200 - SG 11205 and bracket SG 3832:
Screw SG 10492 (M4x8) needed.

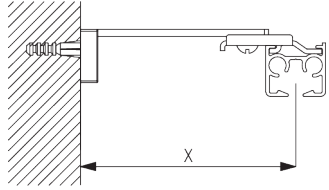

Square Smart Fix SG 11210 - SG 11215 and bracket SG 3832:
Screw SG 10492 (M4x8) needed.

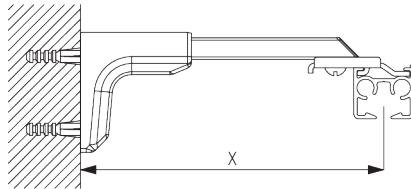

Universal Smart Fix SG 11154 - SG 11156 and bracket SG 3832:
Screw SG 10407 (M4x10) needed.

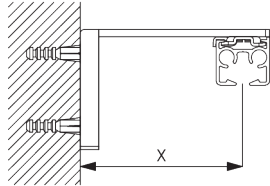

Smart Fix SG 11200 - SG 11205 and clamp SG 3825:
Screw SG 10074 (M4x8) needed.

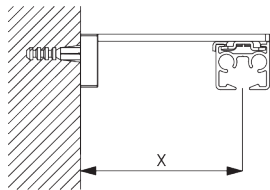

Square Smart Fix SG 11210 - SG 11215 and clamp SG 3825:
Screw SG 10074 (M4x8) needed.

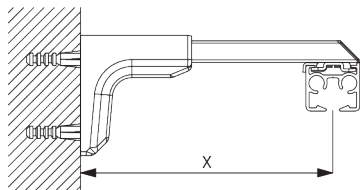

Universal Smart Fix SG 11154 - SG 11156 and clamp SG 3825:
Screw SG 11158 (M4x12) needed.

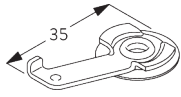

SG 3825
Clamp

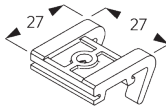

SG 3826
Bracket

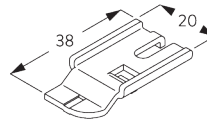

SG 3832
Bracket



SG 10074
Countersunk head screw
M4x8



SG 10277
Pan head screw M4x12



SG 10407
Pan head screw M4x10



SG 10492
Pan head screw M4x8



SG 11158
Countersunk head screw
M4x12

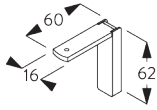

SG 11200
Smart Fix 60 mm

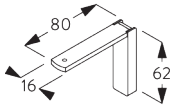

SG 11201
Smart Fix 80 mm

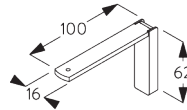

SG 11202
Smart Fix 100 mm

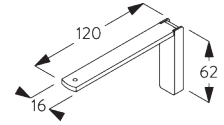

SG 11203
Smart Fix 120 mm

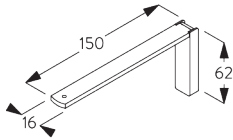

SG 11204
Smart Fix 150 mm

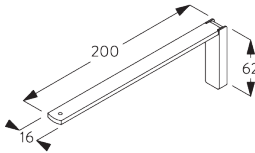

SG 11205
Smart Fix 200 mm

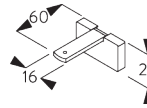

SG 11210
Square Smart Fix 60 mm

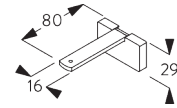

SG 11211
Square Smart Fix 80 mm

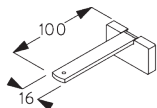

SG 11212
Square Smart Fix 100 mm

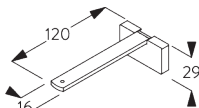

SG 11213
Square Smart Fix 120 mm

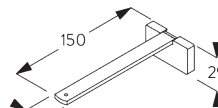

SG 11214
Square Smart Fix 150 mm

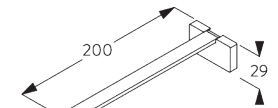

SG 11215
Square Smart Fix 200 mm

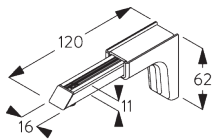

SG 11154
Universal Smart Fix 120 mm

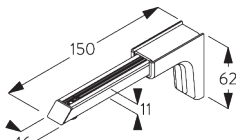

SG 11155
Universal Smart Fix 150 mm

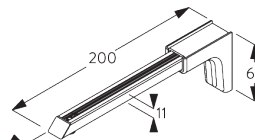

SG 11156
Universal Smart Fix 200 mm

Bracket SG 3836

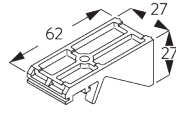
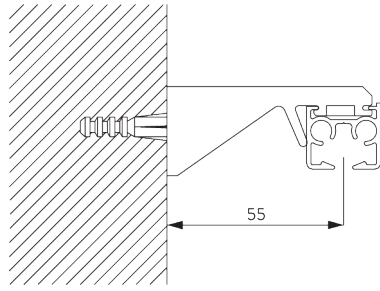

SG 3836

Bracket

D. RECESS FITTING

Recess profile SG 11230

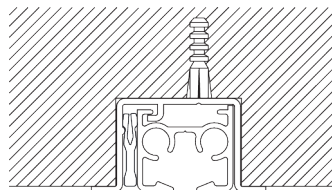

One wedge SG 10157 per fixing point.
For detailed recess fitting, visit the Silent Gliss website.

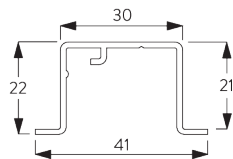

SG 11230

Recess profile

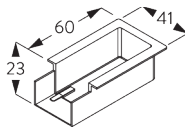

SG 11238

Recess Mask

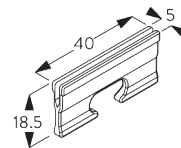

SG 10157

Wedge

SYSTEM OPTIONS

A. WAVE

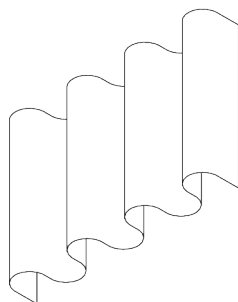

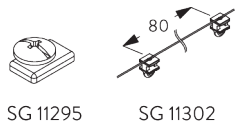

SG 11295

SG 11302

Standard components:

- SG 11295 End stop
- SG 11302 Wave 2C glider cord 80 mm

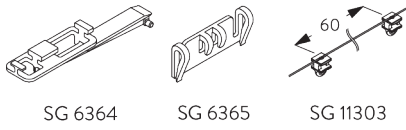

SG 6364

SG 6365

SG 11303

Optional components:

- SG 6364 Wave extension
- SG 6365 Wave hanger
- SG 11303 Wave 2C glider Cord 60 mm

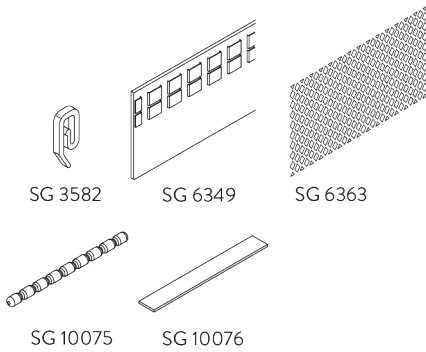

SG 3582

SG 6349

SG 6363

SG 10075

SG 10076

Curtain components:

- SG 3582 Hook
- SG 6349 Wave curtain tape
- SG 6363 Wave top hemming tape
- SG 10075 Lead weight 50 gr/m
- SG 10076 Fabric weight

Wave stack depth - 2C glider cord (standard components)

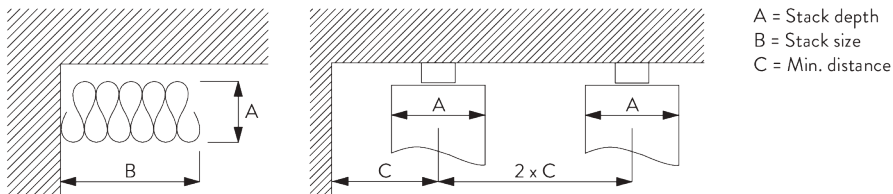

A = Stack depth
B = Stack size
C = Min. distance

2C Glider cord SG 11302	Pockets between hooks*	Approx. curtain fullness	Stack depth A	Stack size B*	Min distance C
80	6	~2.1	140	180 per metre of track	90
80	7	~2.3	160	180 per metre of track	100

2C Glider cord SG 11303	Pockets between hooks*	Approx. curtain fullness	Stack depth A	Stack size B*	Min distance C
60	4	~2.1	100	230 per metre of track	70
60	5	~2.3	120	230 per metre of track	80

***Stack size B standard**







- single stack = plus 130 mm per curtain
- pair stack = plus 30 mm per curtain

***Stack size B optional**



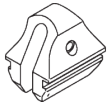



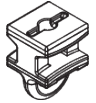



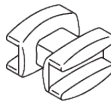





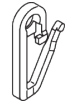

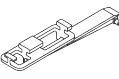
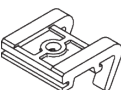
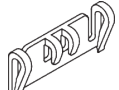
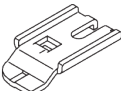

- single stack = plus 200 mm per curtain
- pair stack = plus 200 mm per curtain

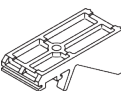
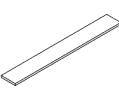
PARTS

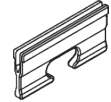
A. STANDARD PARTS

	SG 3090 Cord ø 3.5 mm
	SG 3599 Hook
	SG 3825 Clamp
	SG 6086 Spring stop
	SG 6288 Overlap arm
	SG 10731 Child safety retainer set
	SG 11190 Profile
	SG 11285 Guide set
	SG 11300 2C glider

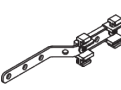
B. OPTIONAL PARTS

	SG 3012 Hook		SG 6082 Glider
	SG 3340 Cord/chain weight		SG 6094 Roller
	SG 3581 Hook		SG 6098 Roller
	SG 3582 Hook		SG 6283 Roller
	SG 3598 Eyelet		SG 6349 Wave curtain tape
	SG 3735 Cord weight with tensioner		SG 6363 Wave top hemming tape
	SG 3802 Connection bridge		SG 6364 Wave extension
	SG 3826 Bracket		SG 6365 Wave hanger
	SG 3832 Bracket		SG 10075 Lead weight 50 g/m
	SG 3836 Bracket		SG 10076 Fabric weight
	SG 6004 Eyelet		SG 10157 Wedge
	SG 6053 Spring stop		SG 10277 Pan head screw M4x12
	SG 6057 Glider		SG 10407 Pan head screw M4x10
	SG 6063 Overlap arm		SG 10492 Pan head screw M4x8

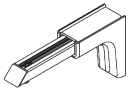

SG 11154
Universal Smart Fix 120 mm

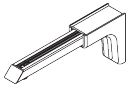

SG 11155
Universal Smart Fix 150 mm

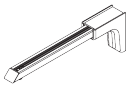

SG 11156
Universal Smart Fix 200 mm

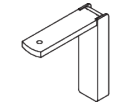

SG 11200
Smart Fix 60 mm

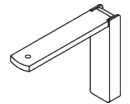

SG 11201
Smart Fix 80 mm

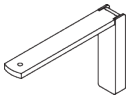

SG 11202
Smart Fix 100 mm

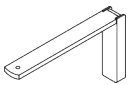

SG 11203
Smart Fix 120 mm



SG 11204
Smart Fix 150 mm



SG 11205
Smart Fix 200 mm

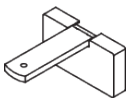

SG 11210
Square Smart Fix 60 mm

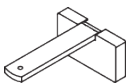

SG 11211
Square Smart Fix 80 mm

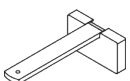

SG 11212
Square Smart Fix 100 mm

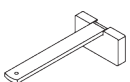

SG 11213
Square Smart Fix 120 mm

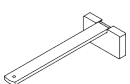

SG 11214
Square Smart Fix 150 mm

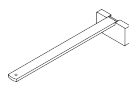

SG 11215
Square Smart Fix 200 mm

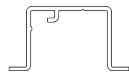

SG 11230
Recess profile

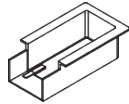

SG 11238
Recess Mask

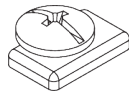

SG 11295
End stop



SG 11301
2C glider on strip

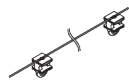

SG 11302
Wave 2C glider cord 80 mm

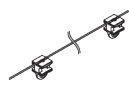

SG 11303
Wave 2C glider cord 60 mm

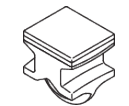

SG 11305
2C glider for direct sewing

