

SG 6100

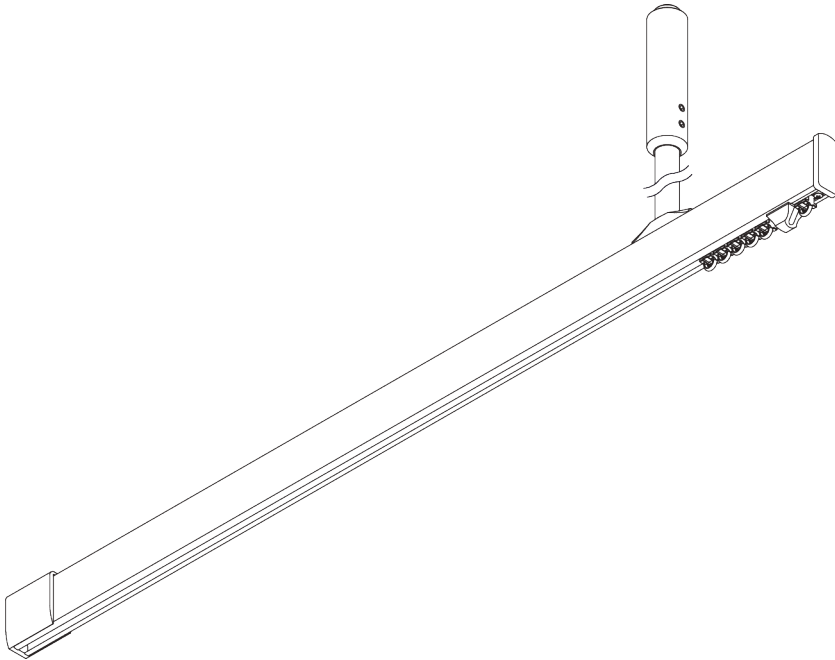

PRODUCT INFORMATION

- **Operation:** hand
- **Range:** S - L
- **Fitting:** suspended, ceiling, wall
- **Colours:** white RAL 9016, black RAL 9005 or anodised aluminum, special colours possible
- **Fabrics:** refer to Silent Gliss fabric collection

Features:

- Universal room divider
- 2-component (2C) glider technology
- Wave (2C)
- Suspended
- Versatile layouts
- Bendable

SYSTEM SPECIFICATIONS

A. PROFILE

Profile and bending information

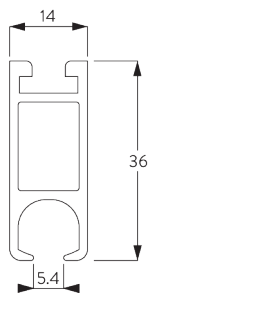

SG 6101

Profile

Radius:
✓ 20 cm, >25 cm

B. HOW TO MEASURE

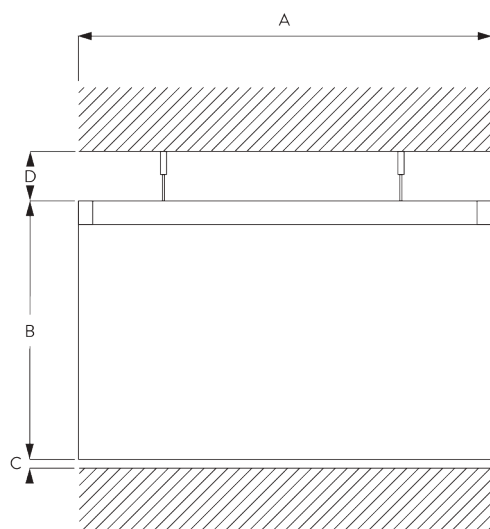

A: System width

B: System height

C: Distance between floor and fabric

D: Distance between ceiling and system

FITTING

A. FITTING INFORMATION

Fixing points

For detailed fitting information, visit the [Silent Gliss website](#).

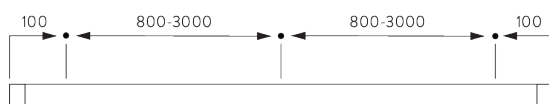

Dust cover

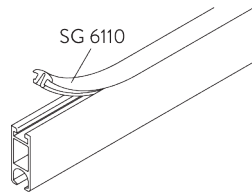

B. CEILING FITTING

Hanger SG 6190 / SG 6196

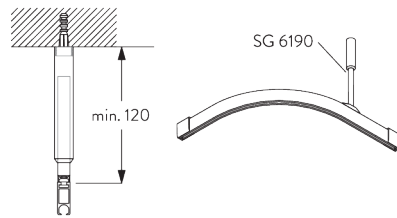

Or variant with SG 6196 double hanger.

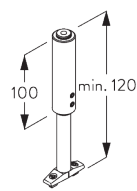

SG 6190

Hanger

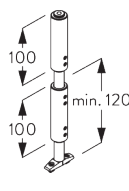

SG 6196

Double hanger

Mini hanger SG 6175

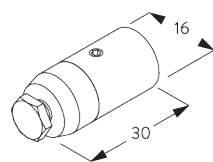
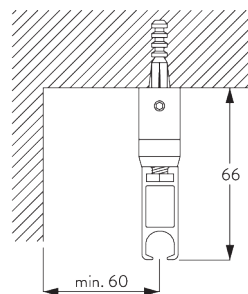

SG 6175

Mini hanger

Bracket SG 6124

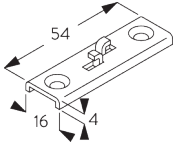
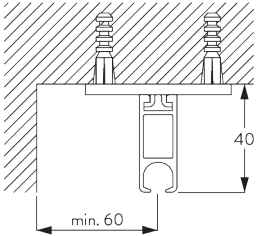

SG 6124
Bracket

V-hanger

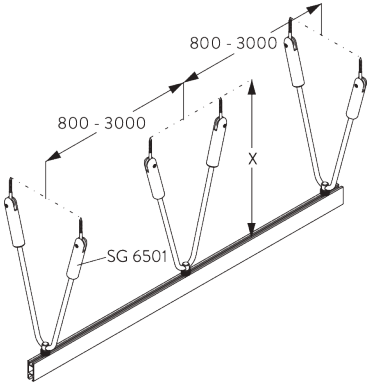

SG 6501:
V-hangers (25°-35°) provide additional lateral stability.

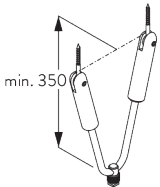

SG 6501
V-Hanger

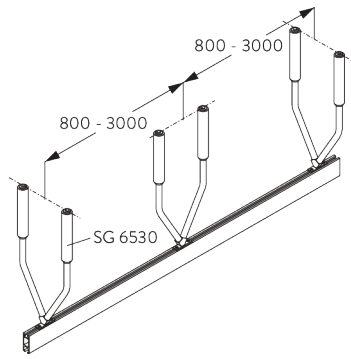

SG 6530:

V-hangers (25°-35°) provide additional lateral stability.

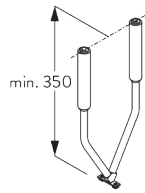

SG 6530

V-Hanger

C. WALL FITTING

Smart Fix

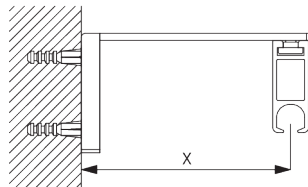

Smart Fix with slot SG 11206 - SG 11208:

Screw SG 10492 (M4x8) needed.

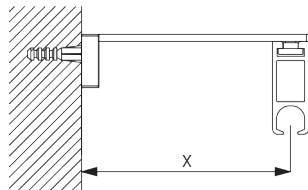

Square Smart Fix with slot SG 11216 - SG 11218:

Screw SG 10492 (M4x8) needed.

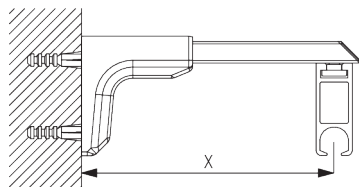

Universal Smart Fix SG 11154 - SG 11156:

Screw SG 11131 (M4x6) needed.

Smart Fix	X mm
SG 11206 / SG 11216	33-51
SG 11207 / SG 11217	53-71
SG 11208 / SG 11218	73-91
SG 11154	102-130
SG 11155	132-160
SG 11156	182-210

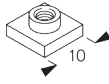

SG 6117
Slot nut



SG 10492
Pan head screw M4x8



SG 11131
Pan head screw with flange
M4x6

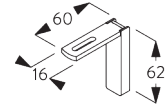

SG 11206
Smart Fix with slot 60 mm

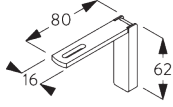

SG 11207
Smart Fix with slot 80 mm

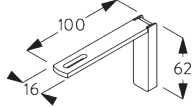

SG 11208
Smart Fix with slot 100 mm

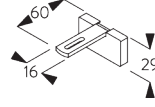

SG 11216
Square Smart Fix with slot 60
mm

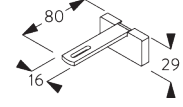

SG 11217
Square Smart Fix with slot 80
mm

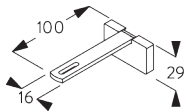

SG 11218
Square Smart Fix with slot
100 mm

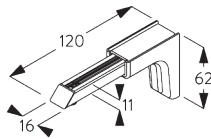

SG 11154
Universal Smart Fix 120 mm

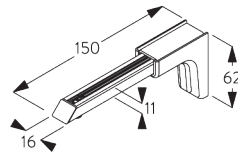

SG 11155
Universal Smart Fix 150 mm

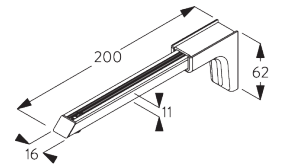

SG 11156
Universal Smart Fix 200 mm

**Wall support SG 6610
& SG 6614**

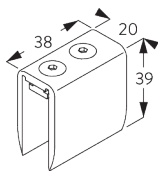
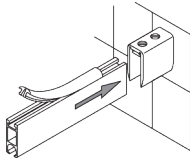

SG 6610
Wall support

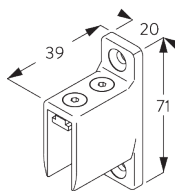

SG 6614
Wall bracket, metal

**D. PROFILE
JUNCTIONS**

**Connection bridge
SG 6123**

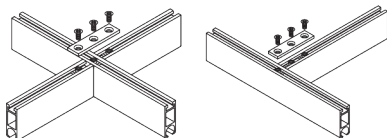

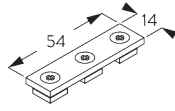

SG 6123

Connection plate

**Connection bridge
SG 6512**

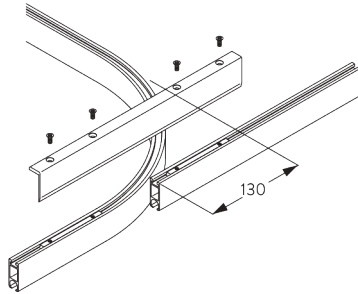
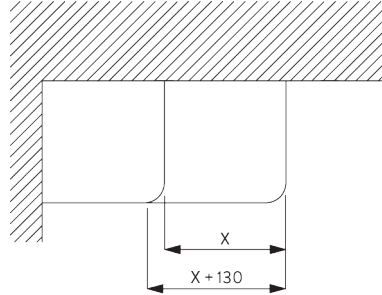

Note: be sure to attach a sketch!

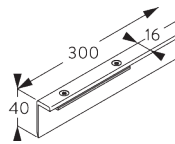

SG 6512

Connection bridge

SYSTEM OPTIONS

A. LAYOUT OPTIONS

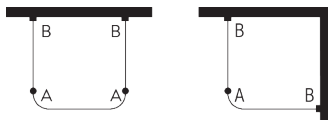

A: Hanger rod
B: Wall support

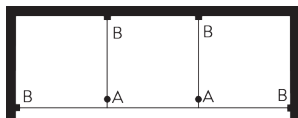

A: Hanger rod
B: Wall support

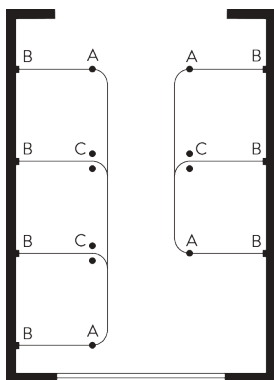

A: Hanger rod
B: Wall support
C: V-hanger

B. WAVE

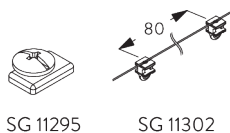
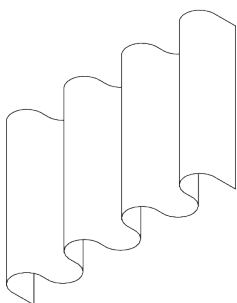

SG 11295

SG 11302

Standard components:

- SG 11295 End stop
- SG 11302 Wave 2C glider cord 80 mm

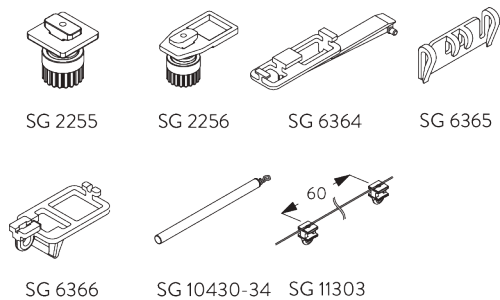

Optional components (min. radius >25 cm):

- SG 2255 Brake
- SG 2256 Brake
- SG 6364 Wave extension
- SG 6365 Wave hanger
- SG 6366 Wave carrier for draw rod
- SG 10430-34 Draw rod
- SG 11303 Wave 2C glider cord 60 mm

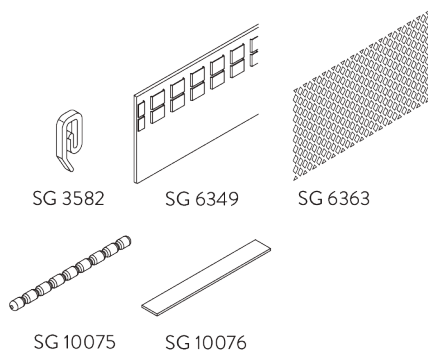

Curtain components:

- SG 3582 Hook
- SG 6349 Wave curtain tape
- SG 6363 Wave top hemming tape
- SG 10075 Lead weight 50 gr/m
- SG 10076 Fabric weight

Wave stack depth - 2C glider cord (standard components)

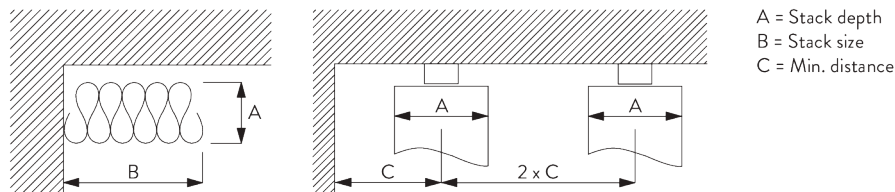

A = Stack depth
 B = Stack size
 C = Min. distance







2C Glider cord SG 11302	Pockets between hooks	Approx. curtain fullness	Stack depth A	Stack size B*	Min distance C
80	6	~2.1	140	180 per metre of track	90
80	7	~2.3	160	180 per metre of track	100

2C Glider cord SG 11303	Pockets between hooks	Approx. curtain fullness	Stack depth A	Stack size B*	Min distance C
60	4	~2.1	100	230 per metre of track	70
60	5	~2.3	120	230 per metre of track	80



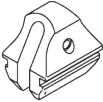

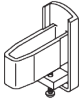





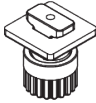
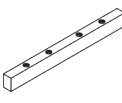
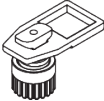
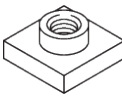

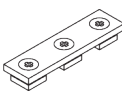
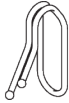
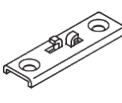





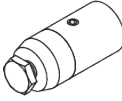

*Stack size B when using optional extension arm SG 6364 increases by 150 mm per curtain stack!

PARTS

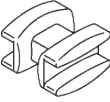
A. STANDARD PARTS

	SG 3599 Hook
	SG 6065 End stop
	SG 6086 Spring stop
	SG 6101 Profile
	SG 6611 End cover
	SG 11300 2C glider

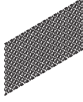
B. OPTIONAL PARTS

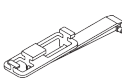
	SG 2255 Brake		SG 6112 Connection bridge
	SG 2256 Brake		SG 6117 Slot nut
	SG 3012 Hook		SG 6123 Connection plate
	SG 3581 Hook		SG 6124 Bracket
	SG 3582 Hook		SG 6143 Glider on strip
	SG 3598 Eyelet		SG 6146 Hook
	SG 6004 Eyelet		SG 6175 Mini hanger
	SG 6005 Hook		SG 6190 Hanger
	SG 6053 Spring stop		SG 6196 Double hanger
	SG 6057 Glider		SG 6240 Roller
	SG 6082 Glider		SG 6283 Roller
	SG 6094 Roller		SG 6349 Wave curtain tape
	SG 6098 Roller		SG 6363 Wave top hemming tape
	SG 6110 Dust cover		SG 6364 Wave extension

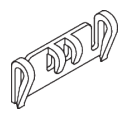

SG 6365
Wave hanger

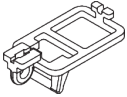

SG 6366
Wave carrier for draw rod



SG 6501
V-Hanger



SG 6512
Connection bridge



SG 6530
V-Hanger

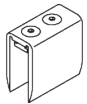

SG 6610
Wall support

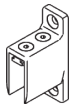

SG 6614
Wall bracket, metal



SG 10075
Lead weight 50 g/m

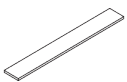

SG 10076
Fabric weight

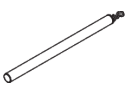

SG 10430
Draw rod 50 cm

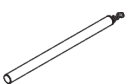

SG 10431
Draw rod 75 cm

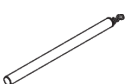

SG 10432
Draw rod 100 cm

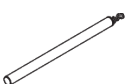

SG 10433
Draw rod 125 cm

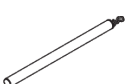

SG 10434
Draw rod 150 cm

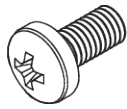

SG 10492
Pan head screw M4x8

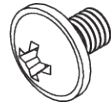

SG 11131
Pan head screw with flange M4x6

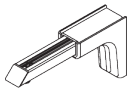

SG 11154
Universal Smart Fix 120 mm

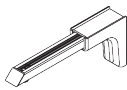

SG 11155
Universal Smart Fix 150 mm

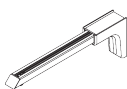

SG 11156
Universal Smart Fix 200 mm

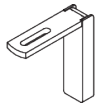

SG 11206
Smart Fix with slot 60 mm

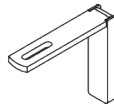

SG 11207
Smart Fix with slot 80 mm

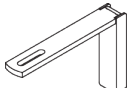

SG 11208
Smart Fix with slot 100 mm

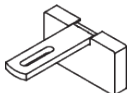

SG 11216
Square Smart Fix with slot 60 mm

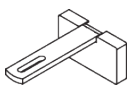

SG 11217
Square Smart Fix with slot 80 mm

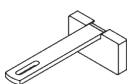

SG 11218
Square Smart Fix with slot 100 mm



SG 11295
End stop



SG 11301
2C glider on strip

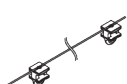

SG 11302
Wave 2C glider cord 80 mm

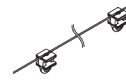

SG 11303
Wave 2C glider cord 60 mm

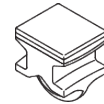

SG 11305
2C glider for direct sewing

