

# SG 6103

---

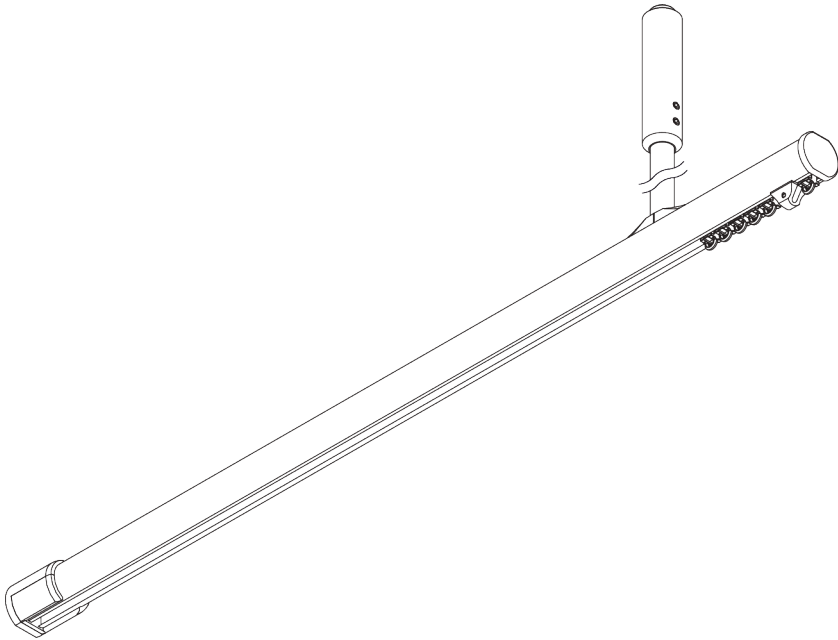
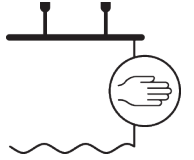

## PRODUCT INFORMATION

- **Operation:** hand
- **Range:** S - L
- **Fitting:** suspended, ceiling, wall
- **Colours:** white RAL 9016 or anodised aluminum, special colours possible
- **Fabrics:** refer to Silent Gliss fabric collection

### **Features:**

- Universal room divider
- 2-component (2C) glider technology
- Wave (2C)
- Suspended
- Versatile layouts
- Bendable

# SYSTEM SPECIFICATIONS

## A. PROFILE

Profile and bending information

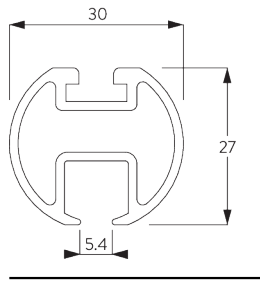

SG 6103p

Profile



## B. HOW TO MEASURE

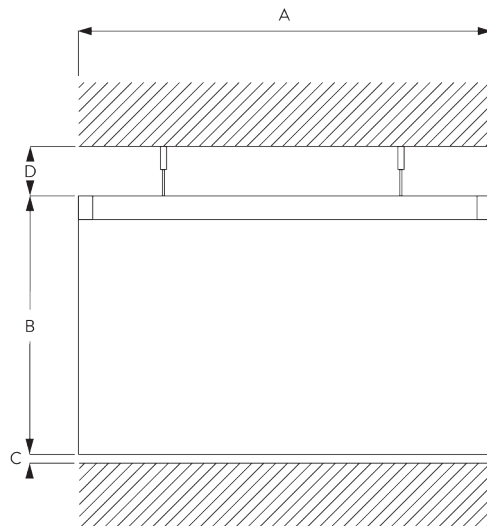

A: System width

B: System height

C: Distance between floor and fabric

D: Distance between ceiling and system

# FITTING

## A. FITTING INFORMATION

Fixing points

For detailed fitting information, visit the [Silent Gliss website](#).

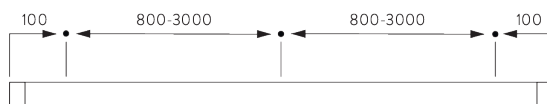

Dust Cover

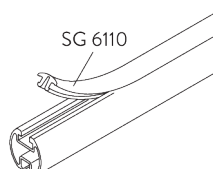

**B. CEILING FITTING**

**Hanger SG 6190 / SG 6196**

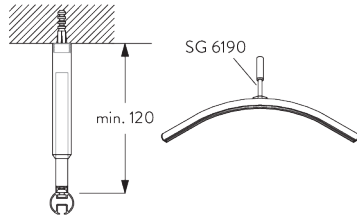

Or variant with SG 6196 double hanger.

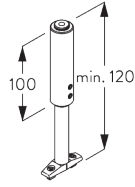

**SG 6190**  
Hanger

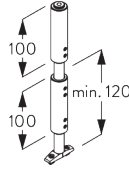

**SG 6196**  
Double hanger

**Mini hanger SG 6175**

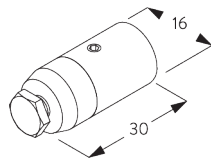
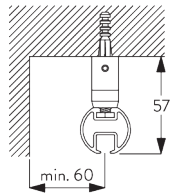

**SG 6175**  
Mini hanger

**Bracket SG 6124**

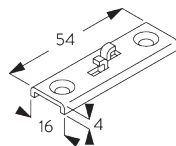
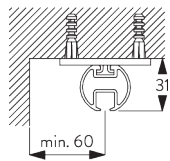

**SG 6124**  
Bracket

## V-hanger

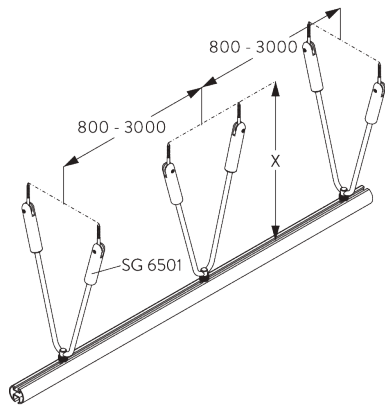

**SG 6501:**  
*V-hangers (25°-35°) provide additional lateral stability.*

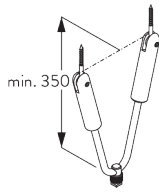

---

**SG 6501**  
*V-Hanger*

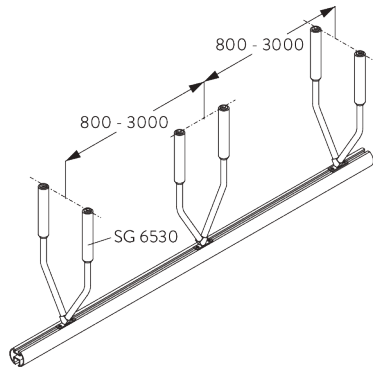

**SG 6530:**  
*V-hangers (25°-35°) provide additional lateral stability.*

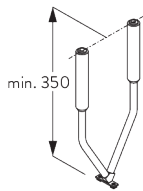

---

**SG 6530**  
*V-Hanger*

## C. WALL FITTING

### Smart Fix

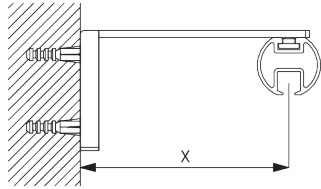

**Smart Fix with slot SG 11206 - SG 11208:**  
Screw SG 10492 (M4x8) needed.

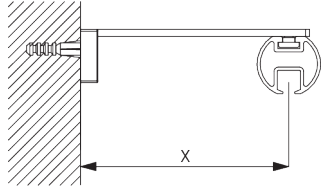

**Square Smart Fix with slot SG 11216 - SG 11218:**  
Screw SG 10492 (M4x8) needed.

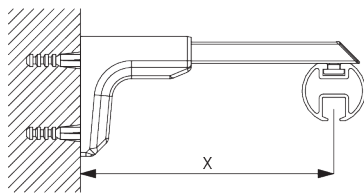

**Universal Smart Fix SG 11154 - SG 11156:**  
Screw SG 11131 (M4x6) needed.

Smart Fix	X mm
SG 11206 / SG 11216	33-51
SG 11207 / SG 11217	53-71
SG 11208 / SG 11218	73-91
SG 11154	102-130
SG 11155	132-160
SG 11156	182-210

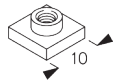

**SG 6117**  
Slot nut



**SG 10492**  
Pan head screw M4x8



**SG 11131**  
Pan head screw with flange  
M4x6

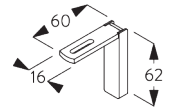

**SG 11206**  
Smart Fix with slot 60 mm

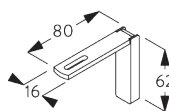

**SG 11207**  
Smart Fix with slot 80 mm

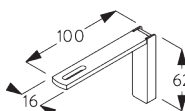

**SG 11208**  
Smart Fix with slot 100 mm

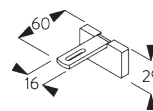

**SG 11216**  
Square Smart Fix with slot 60  
mm

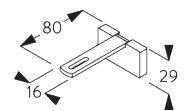

**SG 11217**  
Square Smart Fix with slot 80  
mm

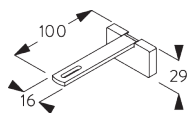

**SG 11218**  
Square Smart Fix with slot  
100 mm

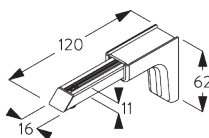

**SG 11154**  
Universal Smart Fix 120 mm

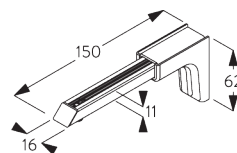

**SG 11155**  
Universal Smart Fix 150 mm

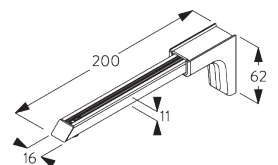

**SG 11156**  
Universal Smart Fix 200 mm

## D. WALL SUPPORT

### Bracket SG 6620

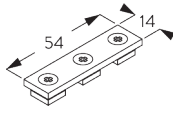
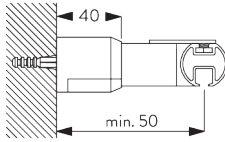

**SG 6123**  
Connection plate

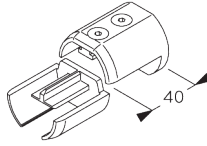

**SG 6620**  
Wall bracket

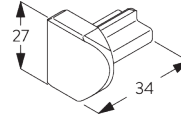

**SG 6631**  
Connection piece

## E. PROFILE JUNCTIONS

### Connection bridge SG 6521

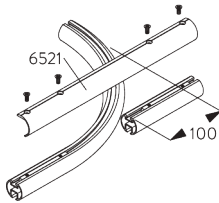
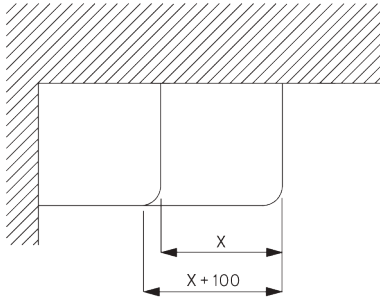

*Note: be sure to attach a sketch!*

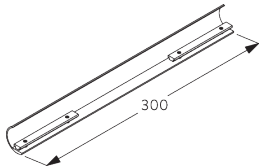

**SG 6521**  
Connection bridge

### Connection set SG 6635

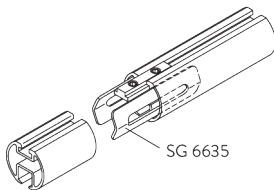

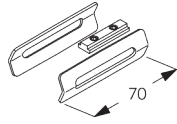

**SG 6635**

Connection bridge set

# SYSTEM OPTIONS

## A. LAYOUT OPTIONS

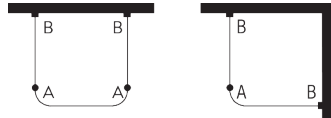

A: Hanger rod  
B: Wall support

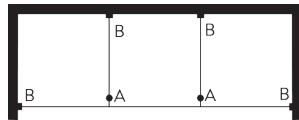

A: Hanger rod  
B: Wall support

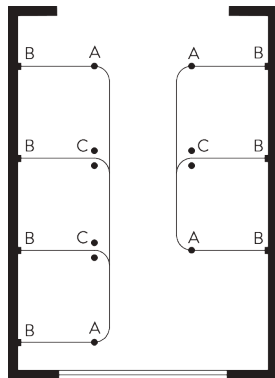

A: Hanger rod  
B: Wall support  
C: V-hanger

## B. WAVE

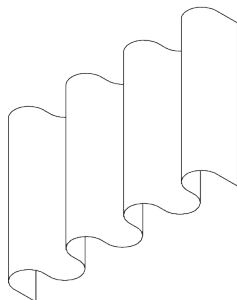

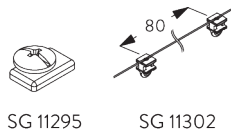

SG 11295

SG 11302

Standard components:

- SG 11295 End stop
- SG 11302 Wave 2C glider cord 80 mm

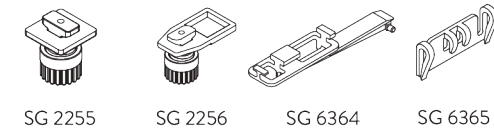

SG 2255

SG 2256

SG 6364

SG 6365

Optional components:

- SG 2255 Brake
- SG 2256 Brake
- SG 6364 Wave extension
- SG 6365 Wave hanger
- SG 6366 Wave carrier for draw rod
- SG 10430-34 Draw rod
- SG 11303 Wave 2C glider cord 60 mm



SG 6366

SG 10430-34

SG 11303

Curtain components:

- SG 3582 Hook
- SG 6349 Wave curtain tape
- SG 6363 Wave top hemming tape
- SG 10075 Lead weight 50 gr/m
- SG 10076 Fabric weight

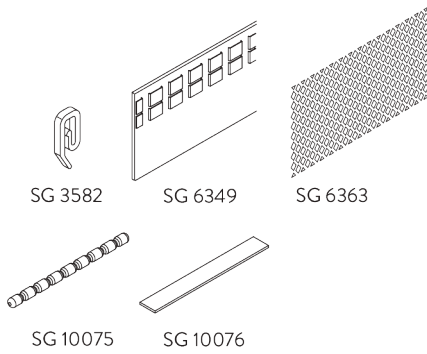

SG 3582

SG 6349

SG 6363

SG 10075

SG 10076

Wave stack depth - 2C glider cord (standard components)

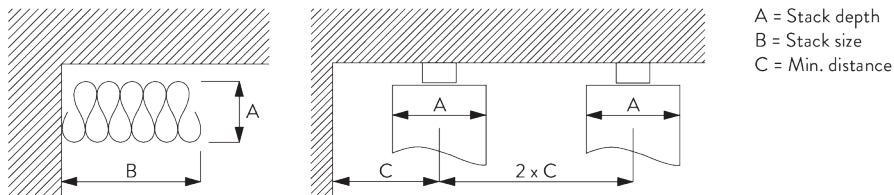

2C Glider cord SG 11302	Pockets between hooks	Approx. curtain fullness	Stack depth A	Stack size B*	Min distance C
80	6	~2.1	140	180 per metre of track	90
80	7	~2.3	160	180 per metre of track	100





2C Glider cord SG 11303	Pockets between hooks	Approx. curtain fullness	Stack depth A	Stack size B*	Min distance C
60	4	~2.1	100	230 per metre of track	70
60	5	~2.3	120	230 per metre of track	80

\*Stack size B when using optional extension arm SG 6364 increases by 150 mm per curtain stack!







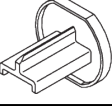
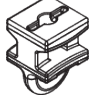



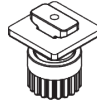
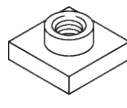
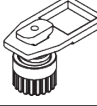
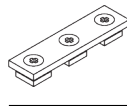

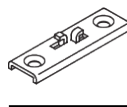
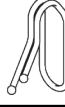
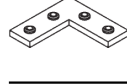





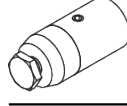

# PARTS

## A. STANDARD PARTS

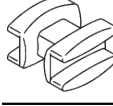
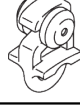
	<b>SG 3599</b> Hook
	<b>SG 6065</b> End stop
	<b>SG 6086</b> Spring stop
	<b>SG 6103p</b> Profile
	<b>SG 6630</b> End cover
	<b>SG 11300</b> 2C glider

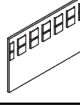
## B. OPTIONAL PARTS

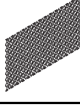
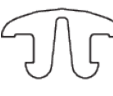
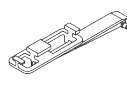
	<b>SG 2255</b> Brake		<b>SG 6117</b> Slot nut
	<b>SG 2256</b> Brake		<b>SG 6123</b> Connection plate
	<b>SG 3012</b> Hook		<b>SG 6124</b> Bracket
	<b>SG 3581</b> Hook		<b>SG 6125</b> Corner connection piece
	<b>SG 3582</b> Hook		<b>SG 6143</b> Glider on strip
	<b>SG 3598</b> Eyelet		<b>SG 6146</b> Hook
	<b>SG 6004</b> Eyelet		<b>SG 6175</b> Mini hanger
	<b>SG 6005</b> Hook		<b>SG 6190</b> Hanger
	<b>SG 6053</b> Spring stop		<b>SG 6196</b> Double hanger
	<b>SG 6057</b> Glider		<b>SG 6240</b> Roller
	<b>SG 6082</b> Glider		<b>SG 6283</b> Roller
	<b>SG 6094</b> Roller		<b>SG 6349</b> Wave curtain tape
	<b>SG 6098</b> Roller		<b>SG 6363</b> Wave top hemming tape
	<b>SG 6110</b> Dust cover		<b>SG 6364</b> Wave extension

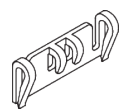

**SG 6365**

Wave hanger

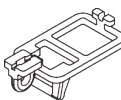

**SG 6366**

Wave carrier for draw rod



**SG 6501**

V-Hanger



**SG 6521**

Connection bridge



**SG 6530**

V-Hanger

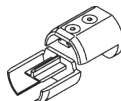

**SG 6620**

Wall bracket

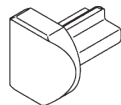

**SG 6631**

Connection piece

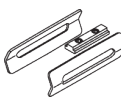

**SG 6635**

Connection bridge set

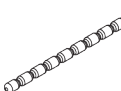

**SG 10075**

Lead weight 50 g/m



**SG 10076**

Fabric weight

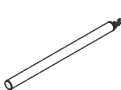

**SG 10430**

Draw rod 50 cm

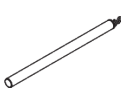

**SG 10431**

Draw rod 75 cm

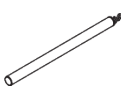

**SG 10432**

Draw rod 100 cm

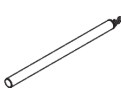

**SG 10433**

Draw rod 125 cm

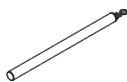

**SG 10434**

Draw rod 150 cm



**SG 10492**

Pan head screw M4x8

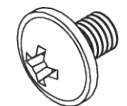

**SG 11131**

Pan head screw with flange M4x6

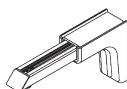

**SG 11154**

Universal Smart Fix 120 mm

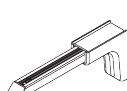

**SG 11155**

Universal Smart Fix 150 mm

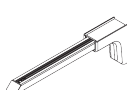

**SG 11156**

Universal Smart Fix 200 mm

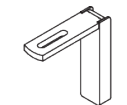

**SG 11206**

Smart Fix with slot 60 mm

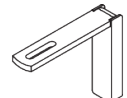

**SG 11207**

Smart Fix with slot 80 mm

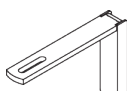

**SG 11208**

Smart Fix with slot 100 mm

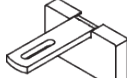

**SG 11216**

Square Smart Fix with slot 60 mm

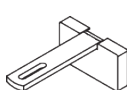

**SG 11217**

Square Smart Fix with slot 80 mm

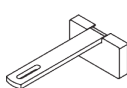

**SG 11218**

Square Smart Fix with slot 100 mm

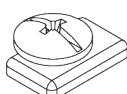

**SG 11295**

End stop



**SG 11301**

2C glider on strip



**SG 11302**

Wave 2C glider cord 80 mm

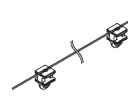

**SG 11303**

Wave 2C glider cord 60 mm

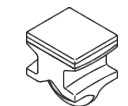

**SG 11305**

2C glider for direct sewing



