

SG 6293

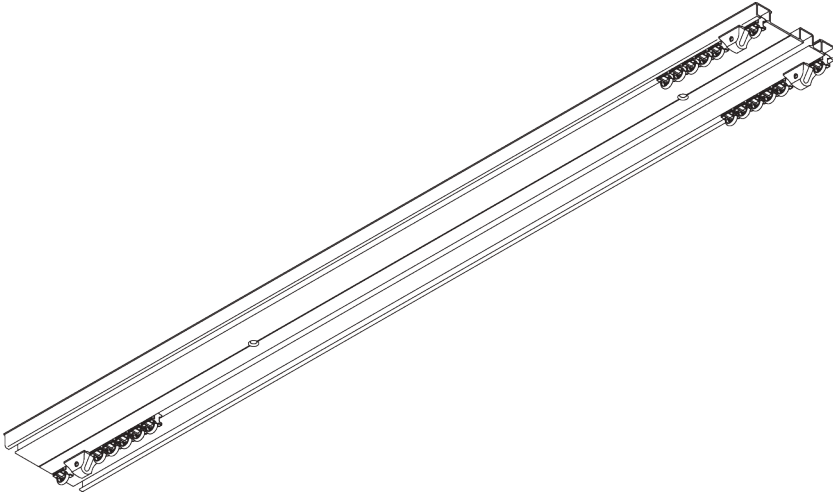

PRODUCT INFORMATION

- **Operation:** hand
- **Range:** M - L
- **Fitting:** ceiling
- **Colours:** white RAL 9016 or anodised aluminum, special colours possible
- **Fabrics:** refer to Silent Gliss fabric collection

Features:

- 2-component (2C) glider technology
- Pre-drilled profile

SYSTEM SPECIFICATIONS

A. PROFILE

Profile information

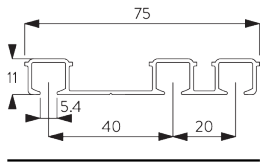

SG 6293p

Profile

B. HOW TO MEASURE

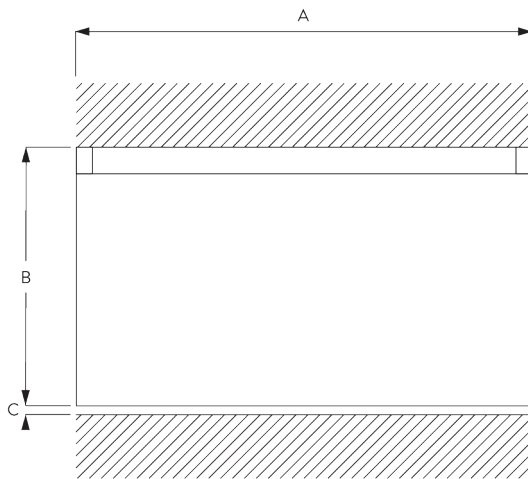

A: System width

B: System height

C: Distance between floor and fabric

FITTING

A. FITTING INFORMATION

Fixing points

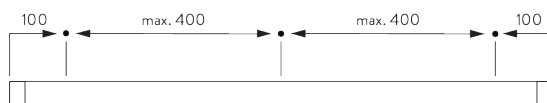

For detailed fitting information, visit the *Silent Gliss* website.



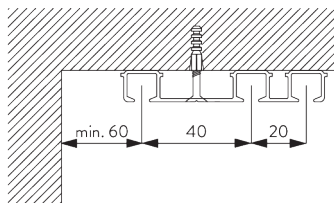

B. CEILING FITTING

Direct fitting





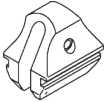





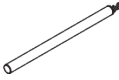

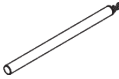
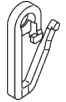
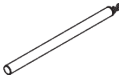

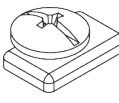
PARTS

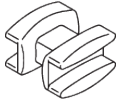
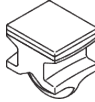
A. STANDARD PARTS

	SG 3599 Hook
	SG 6065 End stop
	SG 6086 Spring stop
	SG 6293p Profile
	SG 11300 2C glider

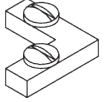
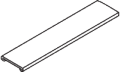
B. OPTIONAL PARTS

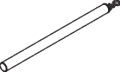
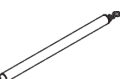
	SG 3012 Hook		SG 10432 Draw rod 100 cm
	SG 3581 Hook		SG 10433 Draw rod 125 cm
	SG 3598 Eyelet		SG 10434 Draw rod 150 cm
	SG 6053 Spring stop		SG 11295 End stop
	SG 6057 Glider		SG 11301 2C glider on strip
	SG 6082 Glider		SG 11305 2C glider for direct sewing
	SG 6094 Roller		
	SG 6098 Roller		
	SG 6240 Roller		
	SG 6246 Corner connection		
	SG 6269 Connection bridge		
	SG 6283 Roller		
	SG 10430 Draw rod 50 cm		
	SG 10431 Draw rod 75 cm		

