

SG 6840

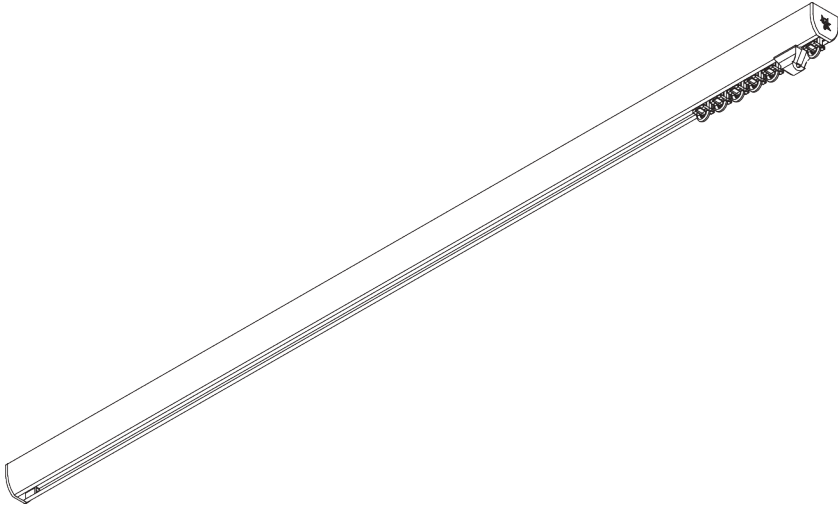

PRODUCT INFORMATION

- **Operation:** hand
- **Range:** M - L
- **Fitting:** ceiling, wall
- **Colours:** white RAL 9016, black RAL 9005 or anodised aluminum, special colours possible
- **Fabrics:** refer to Silent Gliss fabric collection

Features:

- 2-component (2C) glider technology
- Wave (2C)
- Bendable

SYSTEM SPECIFICATIONS

A. PROFILE

Profile and bending information

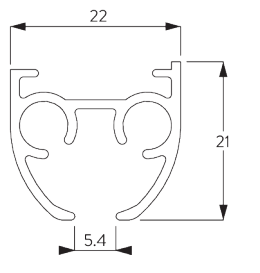

SG 3841

Profile

Radius:
✓ 20 cm, >30 cm

B. HOW TO MEASURE

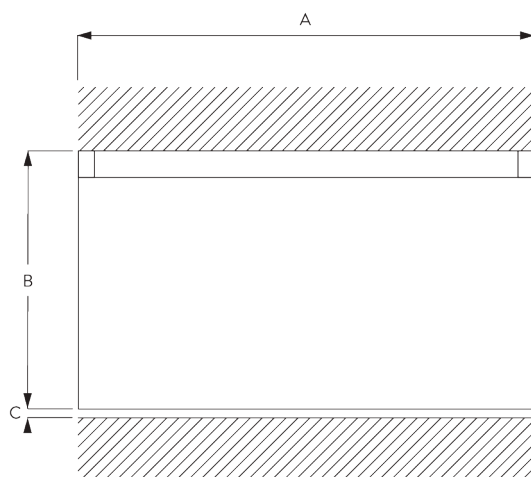

A: System width
B: System height
C: Distance between floor and fabric

FITTING

A. FITTING INFORMATION

Fixing points

For detailed fitting information, visit the [Silent Gliss website](#).

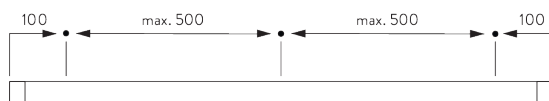

B. CEILING FITTING

Clamp SG 3825

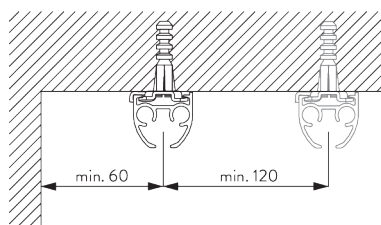

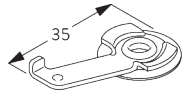

SG 3825

Clamp

Bracket SG 3826

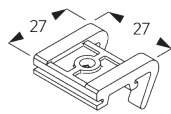
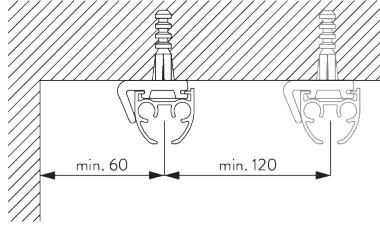

SG 3826

Bracket

Bracket SG 3832

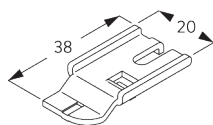
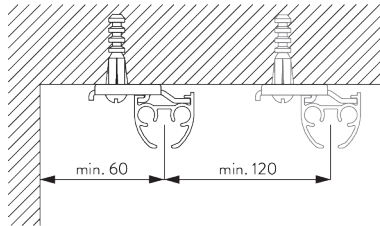

SG 3832

Bracket

C. WALL FITTING

Smart Fix

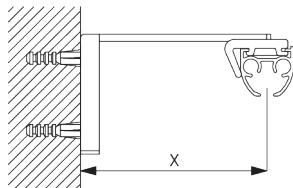

Smart Fix SG 11200 - SG 11205 and bracket SG 3826:
Screw SG 10492 (M4x8) needed.

Smart Fix	X mm (SG 3826 / SG 3825)	X mm (SG 3832)
SG 11200 / SG 11210	52	70
SG 11201 / SG 11211	72	90
SG 11202 / SG 11212	92	110
SG 11203 / SG 11213	112	130
SG 11204 / SG 11214	142	160
SG 11205 / SG 11215	192	210
SG 11154	102-130	120-148
SG 11155	132-160	150-178
SG 11156	182-210	200-228

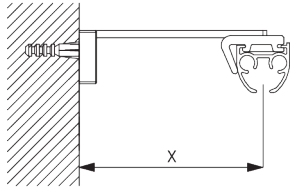

Square Smart Fix SG 11210 - SG 11215 and bracket SG 3826:

Screw SG 10492 (M4x8) needed.

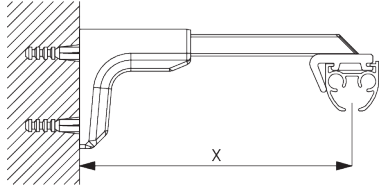

Universal Smart Fix SG 11154 - SG 11156 and bracket SG 3826:

Screw SG 10277 (M4x12) needed.

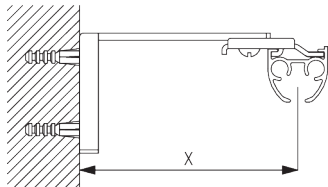

Smart Fix SG 11200 - SG 11205 and bracket SG 3832:

Screw SG 10492 (M4x8) needed.

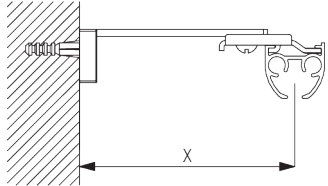

Square Smart Fix SG 11210 - SG 11215 and bracket SG 3832:

Screw SG 10492 (M4x8) needed.

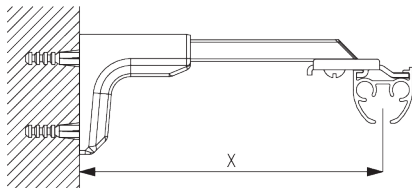

Universal Smart Fix SG 11154 - SG 11156 and bracket SG 3832:

Screw SG 10407 (M4x10) needed.

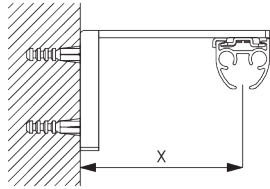

Smart Fix SG 11200 - SG 11205 and clamp SG 3825:
Screw SG 10074 (M4x8) needed.

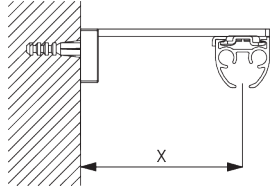

Square Smart Fix SG 11210 - SG 11215 and clamp SG 3825:
Screw SG 10074 (M4x8) needed.

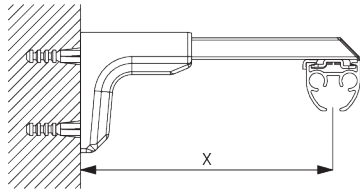

Universal Smart Fix SG 11154 - SG 11156 and clamp SG 3825:
Screw SG 11158 (M4x12) needed.

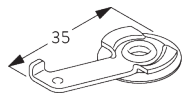

SG 3825
Clamp

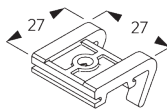

SG 3826
Bracket

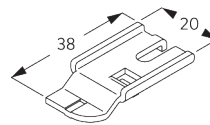

SG 3832
Bracket



SG 10074
Countersunk head screw
M4x8



SG 10277
Pan head screw M4x12



SG 10407
Pan head screw M4x10



SG 10492
Pan head screw M4x8



SG 11158
Countersunk head screw
M4x12

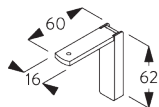

SG 11200
Smart Fix 60 mm

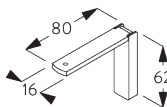

SG 11201
Smart Fix 80 mm

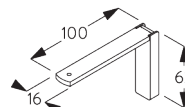

SG 11202
Smart Fix 100 mm

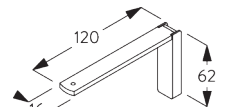

SG 11203
Smart Fix 120 mm

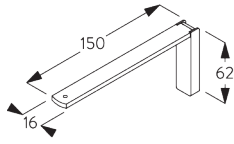

SG 11204
Smart Fix 150 mm

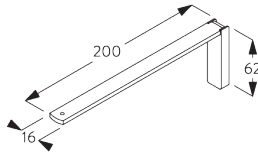

SG 11205
Smart Fix 200 mm

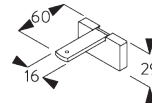

SG 11210
Square Smart Fix 60 mm

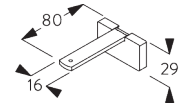

SG 11211
Square Smart Fix 80 mm

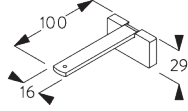

SG 11212
Square Smart Fix 100 mm

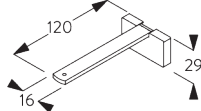

SG 11213
Square Smart Fix 120 mm

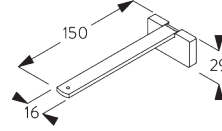

SG 11214
Square Smart Fix 150 mm

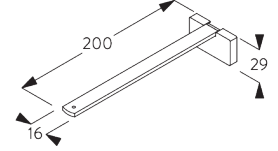

SG 11215
Square Smart Fix 200 mm

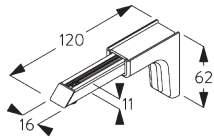

SG 11154
Universal Smart Fix 120 mm

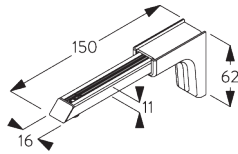

SG 11155
Universal Smart Fix 150 mm

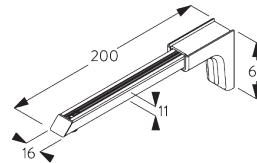

SG 11156
Universal Smart Fix 200 mm

Bracket SG 3836

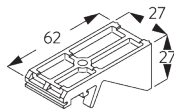
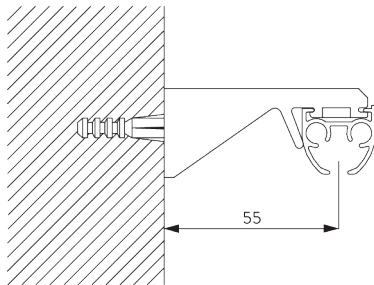

SG 3836
Bracket

SYSTEM OPTIONS

A. WAVE

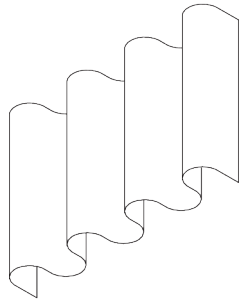

SG 11295

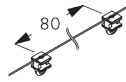

SG 11302



SG 2255



SG 2256

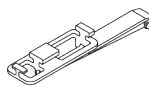

SG 6364



SG 6365

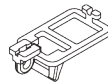

SG 6366

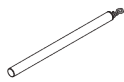

SG 10430-34

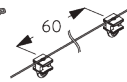

SG 11303

Standard components:

- SG 11295 End stop
- SG 11302 Wave 2C glider cord 80 mm

Optional components (min. Radius: >30 cm):

- SG 2255 Brake
- SG 2256 Brake
- SG 6364 Wave extension
- SG 6365 Wave hanger
- SG 6366 Wave carrier for draw rod
- SG 10430-34 Draw rod
- SG 11303 Wave 2C glider cord 60 mm



SG 3582

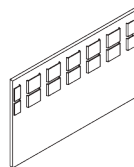

SG 6349

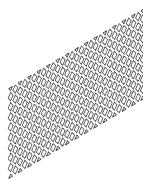

SG 6363



SG 10075



SG 10076

Curtain components:

- SG 3582 Hook
- SG 6349 Wave curtain tape
- SG 6363 Wave top hemming tape
- SG 10075 Lead weight 50 gr/m
- SG 10076 Fabric weight

Wave stack depth - 2C glider cord (standard components)

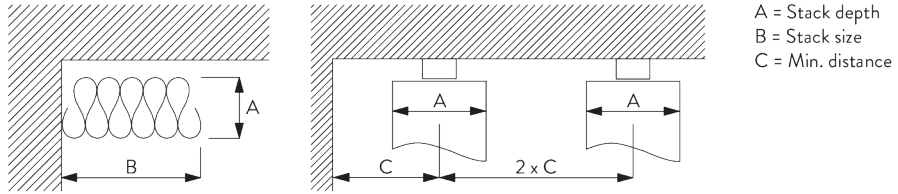







2C Glider cord SG 11302	Pockets between hooks	Approx. curtain fullness	Stack depth A	Stack size B*	Min distance C
80	6	~2.1	140	180 per metre of track	90
80	7	~2.3	160	180 per metre of track	100

2C Glider cord SG 11303	Pockets between hooks	Approx. curtain fullness	Stack depth A	Stack size B*	Min distance C
60	4	~2.1	100	230 per metre of track	70
60	5	~2.3	120	230 per metre of track	80





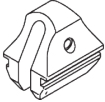



*Stack size B when using optional extension arm SG 6364 increases by 150 mm per curtain stack!

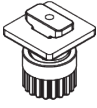
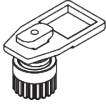



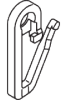
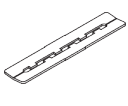
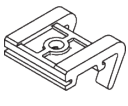
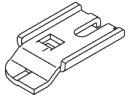
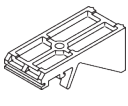

PARTS

A. STANDARD PARTS

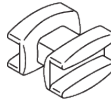
	SG 3599 Hook
	SG 3825 Clamp
	SG 3841 Profile
	SG 3842 End cover
	SG 6065 End stop
	SG 6086 Spring stop
	SG 11300 2C glider

B. OPTIONAL PARTS

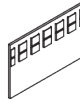
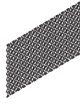
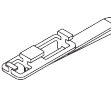
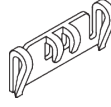
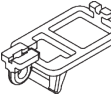
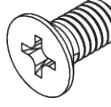
	SG 2255 Brake
	SG 2256 Brake
	SG 3012 Hook
	SG 3581 Hook
	SG 3582 Hook
	SG 3598 Eyelet
	SG 3802 Connection bridge
	SG 3826 Bracket
	SG 3832 Bracket
	SG 3836 Bracket
	SG 6004 Eyelet
	SG 6005 Hook
	SG 6053 Spring stop
	SG 6057 Glider

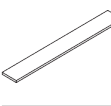
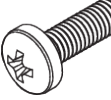
	SG 6082 Glider
	SG 6094 Roller
	SG 6098 Roller
	SG 6240 Roller
	SG 6283 Roller
	SG 6349 Wave curtain tape
	SG 6363 Wave top hemming tape
	SG 6364 Wave extension
	SG 6365 Wave hanger
	SG 6366 Wave carrier for draw rod
	SG 10074 Countersunk head screw M4x8
	SG 10075 Lead weight 50 g/m
	SG 10076 Fabric weight
	SG 10277 Pan head screw M4x12

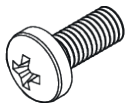

SG 10407

Pan head screw M4x10

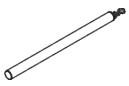

SG 10430

Draw rod 50 cm

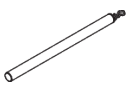

SG 10431

Draw rod 75 cm

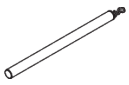

SG 10432

Draw rod 100 cm

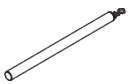

SG 10433

Draw rod 125 cm



SG 10434

Draw rod 150 cm



SG 10492

Pan head screw M4x8

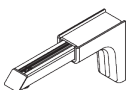

SG 11154

Universal Smart Fix 120 mm

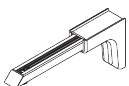

SG 11155

Universal Smart Fix 150 mm

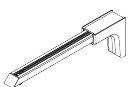

SG 11156

Universal Smart Fix 200 mm

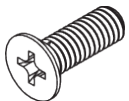

SG 11158

Countersunk head screw M4x12

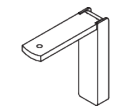

SG 11200

Smart Fix 60 mm

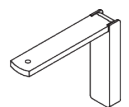

SG 11201

Smart Fix 80 mm

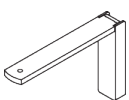

SG 11202

Smart Fix 100 mm

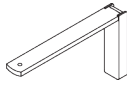

SG 11203

Smart Fix 120 mm

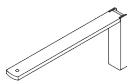

SG 11204

Smart Fix 150 mm



SG 11205

Smart Fix 200 mm

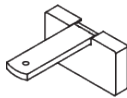

SG 11210

Square Smart Fix 60 mm

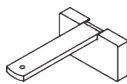

SG 11211

Square Smart Fix 80 mm

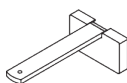

SG 11212

Square Smart Fix 100 mm

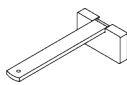

SG 11213

Square Smart Fix 120 mm

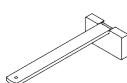

SG 11214

Square Smart Fix 150 mm

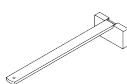

SG 11215

Square Smart Fix 200 mm

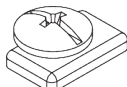

SG 11295

End stop



SG 11301

2C glider on strip

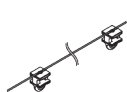

SG 11302

Wave 2C glider cord 80 mm

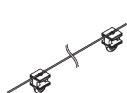

SG 11303

Wave 2C glider cord 60 mm



SG 11305

2C glider for direct sewing

