

SG 6970

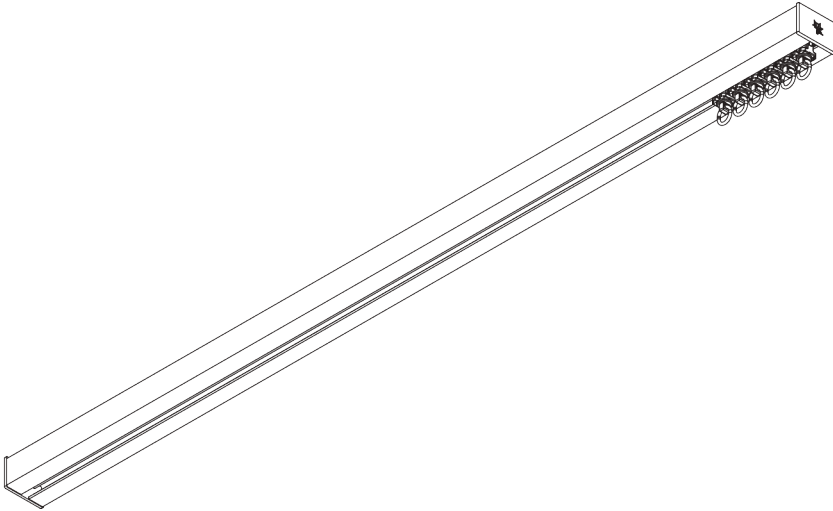

PRODUCT INFORMATION

- **Operation:** hand
- **Range:** M - L
- **Fitting:** ceiling, wall, recess
- **Colours:** white RAL 9016, black RAL 9005 or anodised aluminum, special colours possible (recess profile only in white RAL 9016, black RAL 9005 or special color)
- **Fabrics:** refer to Silent Gliss fabric collection

Features:

- 2-component (2C) roller technology
- Wave (2C)
- Bendable
- Bendable recess profile

SYSTEM SPECIFICATIONS

A. PROFILE

Profile and bending information

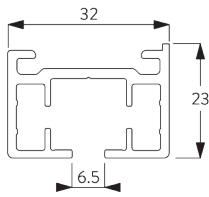

SG 10850

Profile

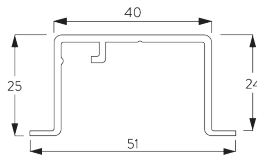

SG 10862

Recess profile



B. HOW TO MEASURE

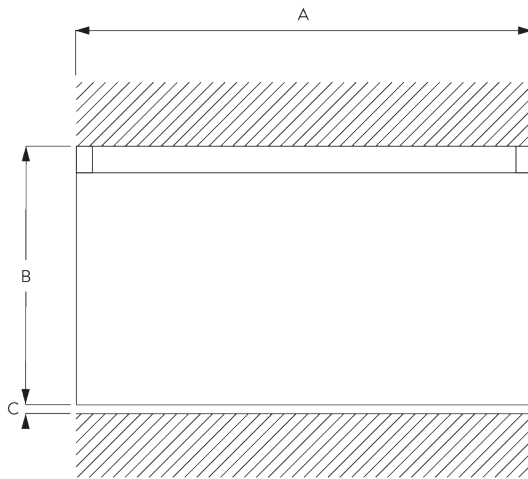

A: System width
B: System height
C: Distance between floor and fabric

FITTING

A. FITTING INFORMATION

Fixing points

For detailed fitting information, visit the [Silent Gliss website](#).

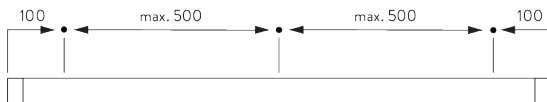

B. CEILING FITTING

Clamp SG 3004

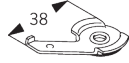
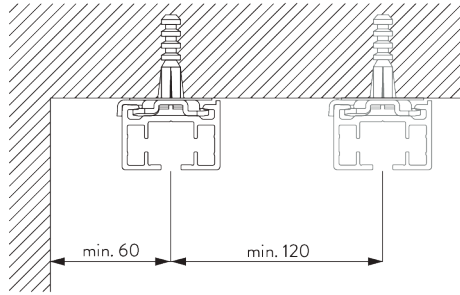

SG 3004

Clamp

Direct fitting

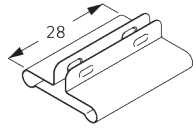
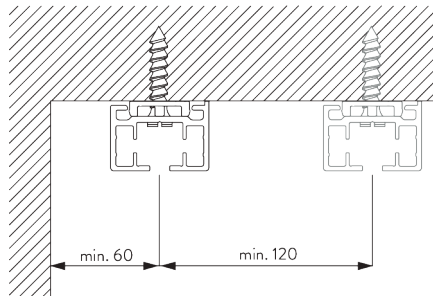

SG 7002

Profile protector

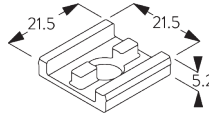

SG 10865

Support plate

Bracket SG 3041

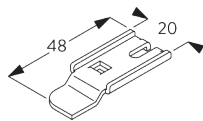
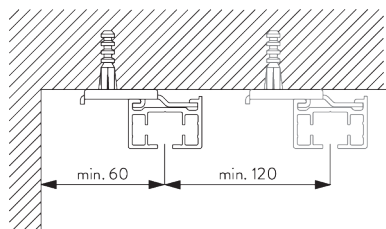

SG 3041

Bracket

C. WALL FITTING

Smart Fix

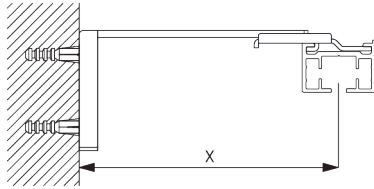

Smart Fix SG 11200 - SG 11205 and bracket SG 3041:
Screw SG 10492 (M4x8) needed.

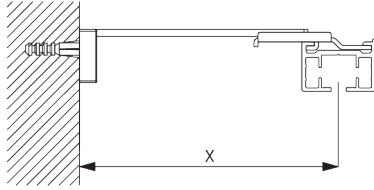

Square Smart Fix SG 11210 - SG 11215 and bracket SG 3041:
Screw SG 10492 (M4x8) needed.

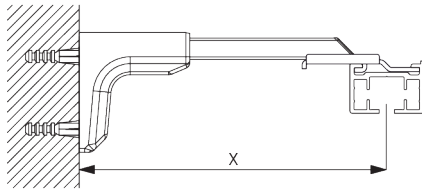

Universal Smart Fix SG 11154 - SG 11156 and bracket SG 3041:
Screw SG 10407 (M4x10) needed.

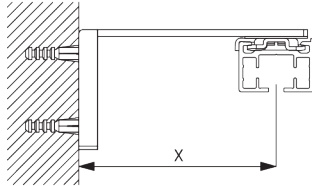

Smart Fix SG 11201 - SG 11205 and clamp SG 3004:
Screw SG 10074 (M4x8) needed.

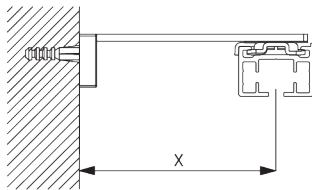

Square Smart Fix SG 11211 - SG 11215 and clamp SG 3004:
Screw SG 10074 (M4x8) needed.

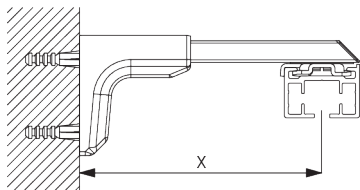

Universal Smart Fix SG 11154 - SG 11156 and clamp SG 3004:
Screw SG 11158 (M4x12) needed.

Smart Fix	X mm (SG 3041)	X mm (SG 3004)
SG 11200 / SG 11210	83	
SG 11201 / SG 11211	103	72
SG 11202 / SG 11212	123	92
SG 11203 / SG 11213	143	112
SG 11204 / SG 11214	173	142
SG 11205 / SG 11215	223	192
SG 11154	128-156	102-130
SG 11155	158-186	132-160
SG 11156	208-236	182-210

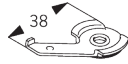

SG 3004
Clamp

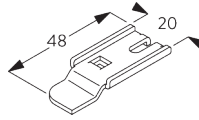

SG 3041
Bracket



SG 10074
Countersunk head screw
M4x8



SG 10407
Pan head screw M4x10



SG 10492
Pan head screw M4x8



SG 11158
Countersunk head screw
M4x12

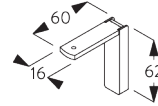

SG 11200
Smart Fix 60 mm

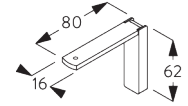

SG 11201
Smart Fix 80 mm

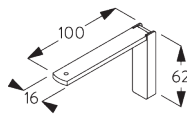

SG 11202
Smart Fix 100 mm

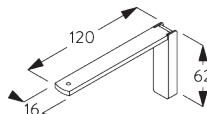

SG 11203
Smart Fix 120 mm

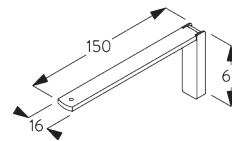

SG 11204
Smart Fix 150 mm

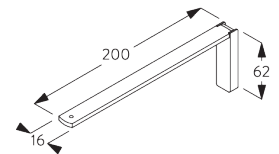

SG 11205
Smart Fix 200 mm

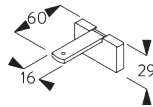

SG 11210
Square Smart Fix 60 mm

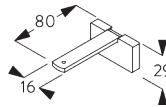

SG 11211
Square Smart Fix 80 mm

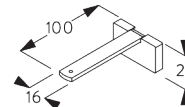

SG 11212
Square Smart Fix 100 mm

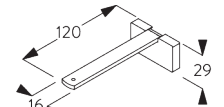

SG 11213
Square Smart Fix 120 mm

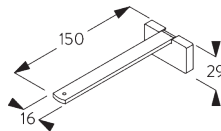

SG 11214
Square Smart Fix 150 mm

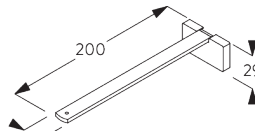

SG 11215
Square Smart Fix 200 mm

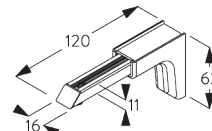

SG 11154
Universal Smart Fix 120 mm

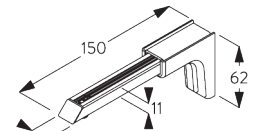

SG 11155
Universal Smart Fix 150 mm

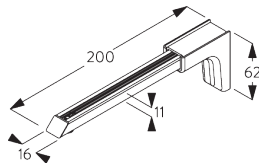

SG 11156
Universal Smart Fix 200 mm

D. RECESS FITTING

Recess profile SG 10862

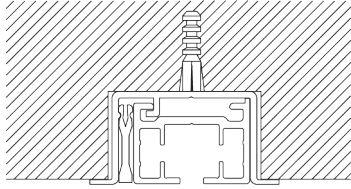

One wedge SG 5118 per fixing point.
For detailed recess fitting, visit the Silent Gliss website.

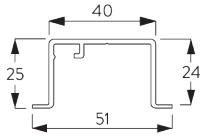

SG 10862
Recess profile

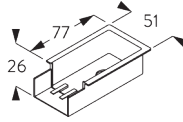

SG 10864
Recess mask

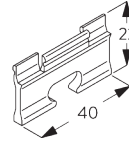

SG 5118
Wedge

E. SUSPENDED FITTING

Hanger SG 6105

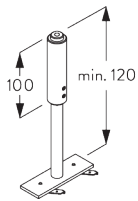
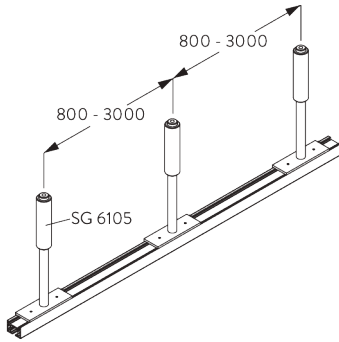

SG 6105
Hanger with plate

V-hanger SG 6107

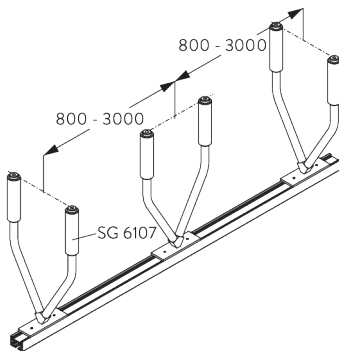

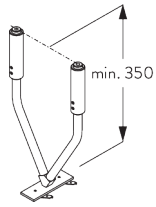

SG 6107
V-Hanger with plate

SYSTEM OPTIONS

A. WAVE

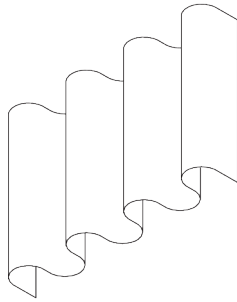

SG 11295

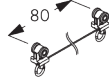

SG 10852

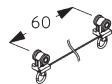

SG 10869

Standard components:

- SG 11295 End stop
- SG 10852 Wave 2C roller cord 80 mm

Optional components:

- SG 10869 Wave 2C roller cord 60 mm



SG 3582

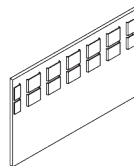

SG 6349

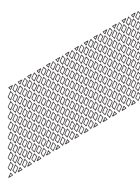

SG 6363

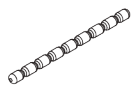

SG 10075



SG 10076

Curtain components:

- SG 3582 Hook
- SG 6349 Wave curtain tape
- SG 6363 Wave top hemming tape
- SG 10075 Lead weight 50 gr/m
- SG 10076 Fabric weight

Wave stack depth - 2C roller cord (standard components)

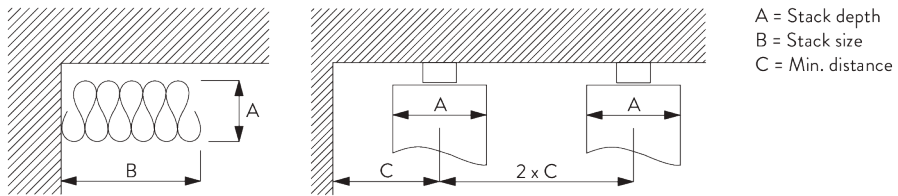



2C Roller cord SG 10852	Pockets between hooks	Approx. curtain fullness	Stack depth A	Stack size B	Min distance C
80	6	~2.1	140	210 per metre of track	90
80	7	~2.3	160	210 per metre of track	100





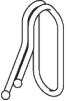

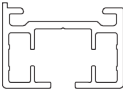
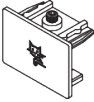
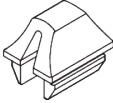

2C Roller cord SG 10869	Pockets between hooks	Approx. curtain fullness	Stack depth A	Stack size B	Min distance C
60	4	~2.1	100	260 per metre of track	70
60	5	~2.3	120	260 per metre of track	80

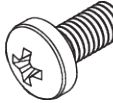
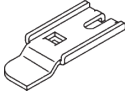
PARTS

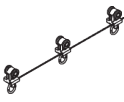
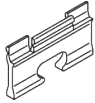
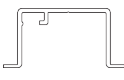
A. STANDARD PARTS

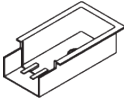
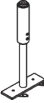
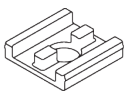
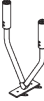
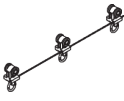
	SG 3004 Clamp
	SG 3581 Hook
	SG 10840 2C roller
	SG 10850 Profile
	SG 11235 End cover
	SG 11465 Spring stop

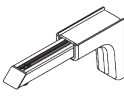
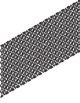
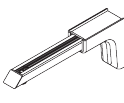
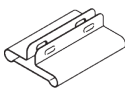
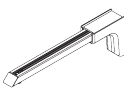
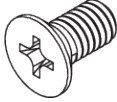
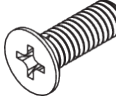
B. OPTIONAL PARTS

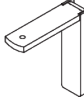
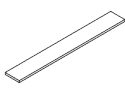
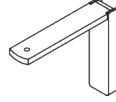
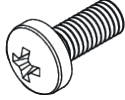
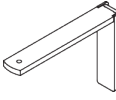
	SG 3012 Hook		SG 10492 Pan head screw M4x8
	SG 3041 Bracket		SG 10831 Connection bridge
	SG 3582 Hook		SG 10852 Wave 2C roller cord 80 mm
	SG 5118 Wedge		SG 10862 Recess profile
	SG 6005 Hook		SG 10864 Recess mask
	SG 6105 Hanger with plate		SG 10865 Support plate
	SG 6107 V-Hanger with plate		SG 10869 Wave 2C roller cord 60 mm
	SG 6349 Wave curtain tape		SG 11154 Universal Smart Fix 120 mm
	SG 6363 Wave top hemming tape		SG 11155 Universal Smart Fix 150 mm
	SG 7002 Profile protector		SG 11156 Universal Smart Fix 200 mm
	SG 10074 Countersunk head screw M4x8		SG 11158 Countersunk head screw M4x12
	SG 10075 Lead weight 50 g/m		SG 11200 Smart Fix 60 mm
	SG 10076 Fabric weight		SG 11201 Smart Fix 80 mm
	SG 10407 Pan head screw M4x10		SG 11202 Smart Fix 100 mm

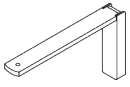

SG 11203

Smart Fix 120 mm

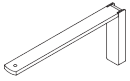

SG 11204

Smart Fix 150 mm

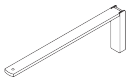

SG 11205

Smart Fix 200 mm

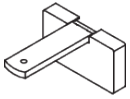

SG 11210

Square Smart Fix 60 mm

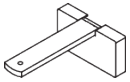

SG 11211

Square Smart Fix 80 mm

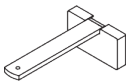

SG 11212

Square Smart Fix 100 mm

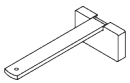

SG 11213

Square Smart Fix 120 mm

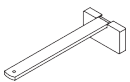

SG 11214

Square Smart Fix 150 mm

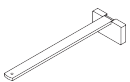

SG 11215

Square Smart Fix 200 mm

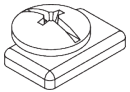

SG 11295

End stop
