

# SG 2700

---

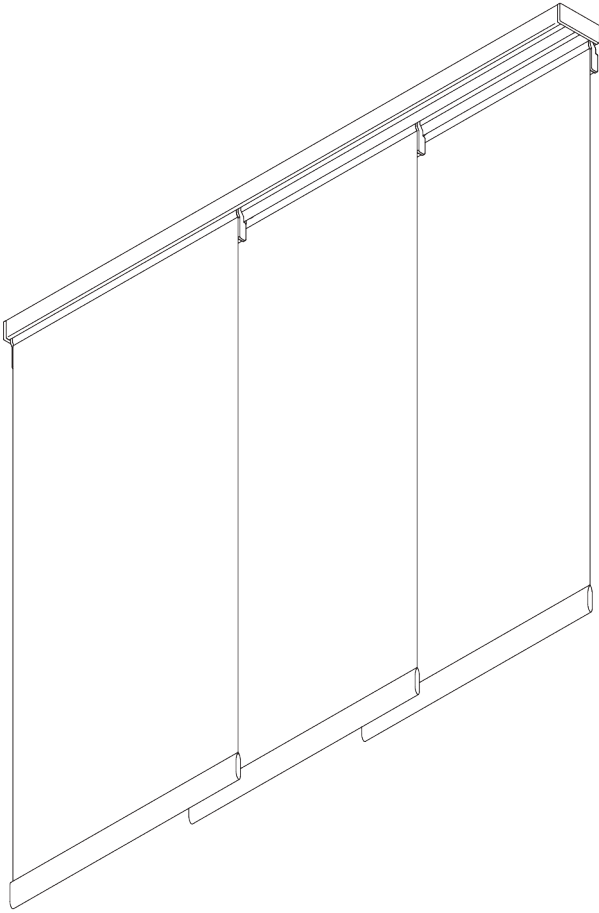
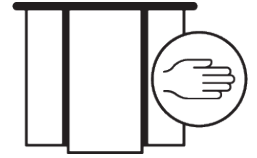

## PRODUCT INFORMATION

- **Operation:** hand
- **Range:** S - L
- **Fitting:** ceiling, wall, recess
- **Colours:** white RAL 9016 or anodised aluminum, special colours possible
- **Fabrics:** refer to Silent Gliss fabric collection

### **Features:**

- 2-component (2C) roller technology
- Silent and smooth running
- Aluminium carriers
- Free floating or connected panels

# SYSTEM SPECIFICATIONS

## A. SYSTEM DIMENSIONS



Panels free floating:  
unlimited  
Panels connected: 6 m

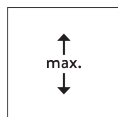

4 m



Max. 2 kg per m

## B. PROFILE

### Profile information

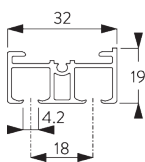

**SG 10122**  
Profile 2-channel

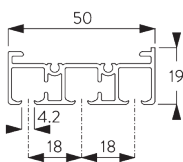

**SG 10123**  
Profile 3-channel

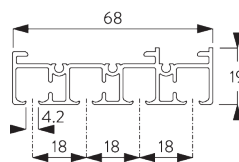

**SG 10124**  
Profile 4-channel

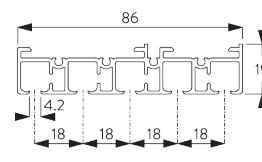

**SG 10125**  
Profile 5-channel

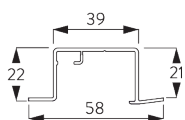

**SG 10172**  
Recess profile 2-channel

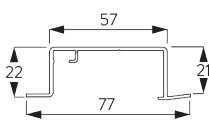

**SG 10173**  
Recess profile 3-channel

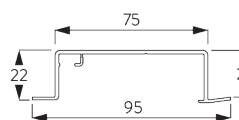

**SG 10174**  
Recess profile 4-channel

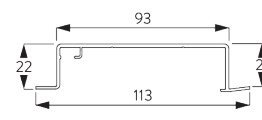

**SG 10175**  
Recess profile 5-channel

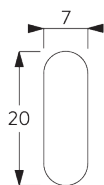

**SG 2004**  
Bottom bar 20x7 mm

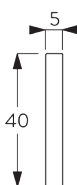

**SG 2005**  
Bottom bar 40x5 mm

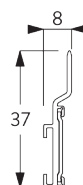

**SG 10230**  
Carrier alu

**C. HOW TO  
MEASURE**

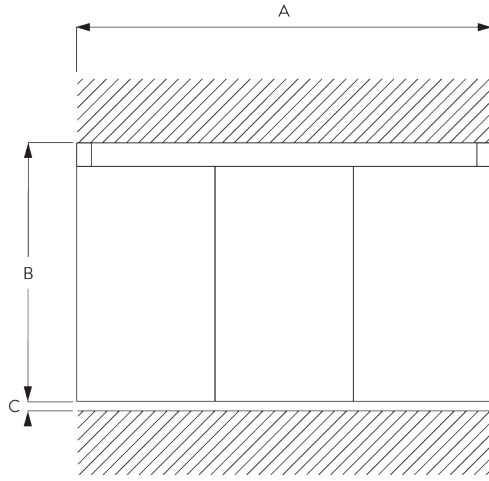

A: System width  
B: System height  
C: Distance between floor and fabric

**Dimensions of Panels**

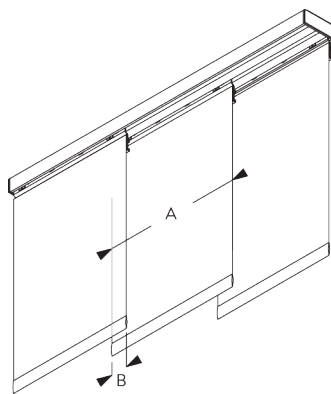

**Free floating:**

A: Recommended panel width: 500 - 1200

**Connected:**

A: Recommended panel width: 500 - 1200

B: Overlap: min. 50

**FITTING**

**A. FITTING  
INFORMATION**

For detailed fitting information, visit the Silent Gliss website.

**Fixing points**

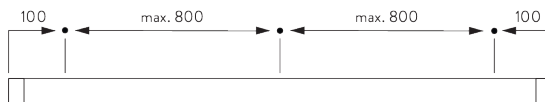

**B. CEILING FITTING**

Clamp SG 3003 / SG 3004

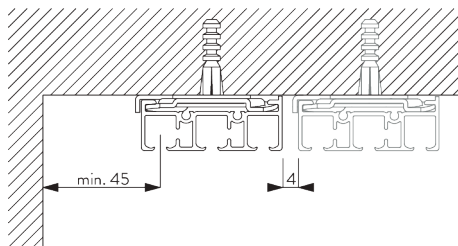

Clamp	SG 10122	SG 10123	SG 10124	SG 10125
SG 3004	X			
SG 3003		X	X	X

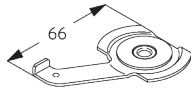

**SG 3003**  
Clamp

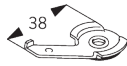

**SG 3004**  
Clamp

**Bracket SG 10136 / SG 10137**

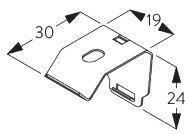
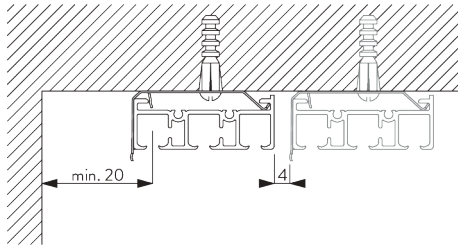

**SG 10136**  
Bracket

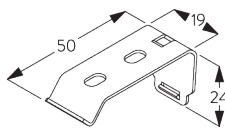

**SG 10137**  
Bracket

Bracket	SG 10122	SG 10123	SG 10124
SG 10136	X		
SG 10137		X	X

**C. WALL FITTING**

**Smart Fix**

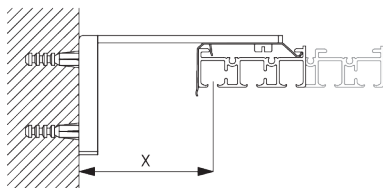

**Smart Fix SG 11200 - SG 11204:**  
Bracket SG 10136 for 2 channel profile.  
Bracket SG 10137 for more than 2 channel profiles.  
Screw SG 10395 (M4x6) needed.

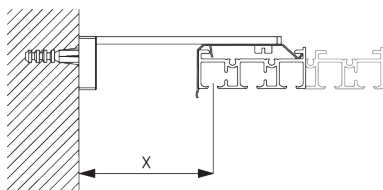

**Square Smart Fix SG 11210 - SG 11214:**  
Bracket SG 10136 for 2 channel profile.  
Bracket SG 10137 for more than 2 channel profiles.  
Screw SG 10395 (M4x6) needed.

Smart Fix	X mm (SG 10122)	X mm (SG 10123)	X mm (SG 10124)	X mm (SG 10125)
SG 11200 / SG 11210	43	24	24	24
SG 11201 / SG 11211	63	44	44	44
SG 11202 / SG 11212	83	64	64	64
SG 11203 / SG 11213	103	84	84	84
SG 11204 / SG 11214	133	114	114	114
SG 11154	93-121	74-102	74-102	74-102
SG 11155	123-151	104-132	104-132	104-132
SG 11156	172-201	154-182	154-182	154-182

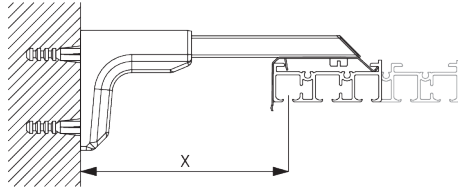

**Universal Smart Fix SG 11154 - SG 11156:**

Bracket SG 10136 for 2 channel profile.

Bracket SG 10137 for more than 2 channel profiles.

Screw SG 10492 (M4x8) needed.

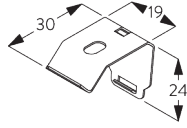

**SG 10136**

Bracket

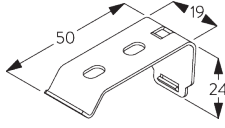

**SG 10137**

Bracket



**SG 10395**

Pan head screw M4x6



**SG 10492**

Pan head screw M4x8

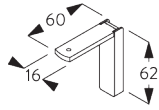

**SG 11200**

Smart Fix 60 mm

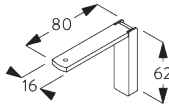

**SG 11201**

Smart Fix 80 mm

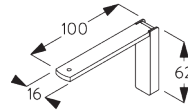

**SG 11202**

Smart Fix 100 mm

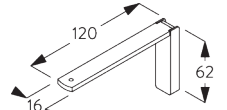

**SG 11203**

Smart Fix 120 mm

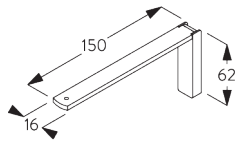

**SG 11204**

Smart Fix 150 mm

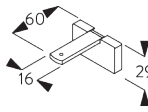

**SG 11210**

Square Smart Fix 60 mm

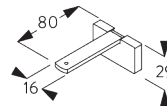

**SG 11211**

Square Smart Fix 80 mm

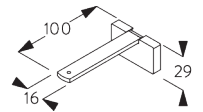

**SG 11212**

Square Smart Fix 100 mm

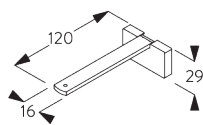

**SG 11213**

Square Smart Fix 120 mm

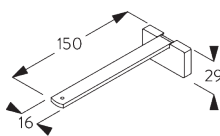

**SG 11214**

Square Smart Fix 150 mm

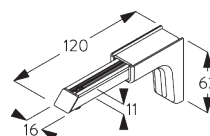

**SG 11154**

Universal Smart Fix 120 mm

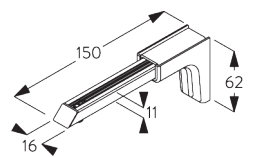

**SG 11155**

Universal Smart Fix 150 mm

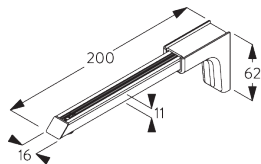

**SG 11156**

Universal Smart Fix 200 mm

## D. RECESS FITTING

### Recess profiles SG 10172 - SG 10175

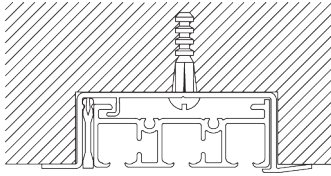

One wedge SG 10157 per fixing point.  
For detailed recess fitting, visit the Silent Gliss website.

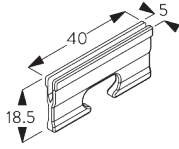

**SG 10157**  
Wedge

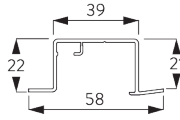

**SG 10172**  
Recess profile 2-channel

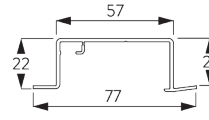

**SG 10173**  
Recess profile 3-channel

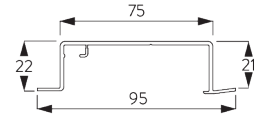

**SG 10174**  
Recess profile 4-channel

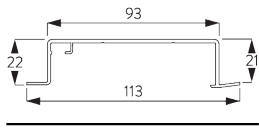

**SG 10175**  
Recess profile 5-channel

# SYSTEM OPTIONS

## A. OPERATION

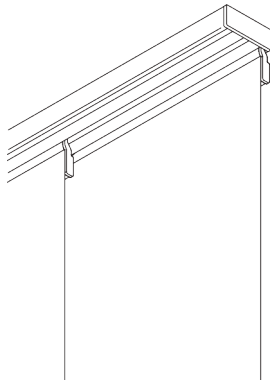

Free floating (unconnected panels)

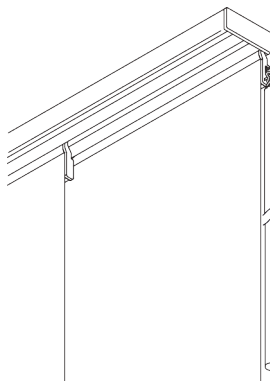

Connected panels (draw rod optional)

**B. PANEL STACKING**  
**(CONNECTED)**



*Single stack*  
*Note: dot = fixed panel*









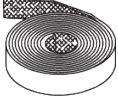

*Pair stack*  
*Note: dot = fixed panel*

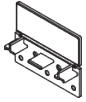

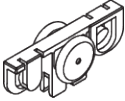





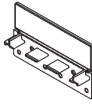

*Other variations are possible.*

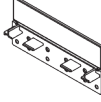
# PARTS

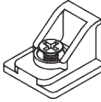
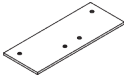
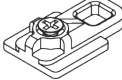
## A. STANDARD PARTS

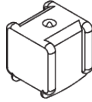
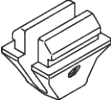
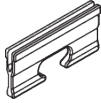
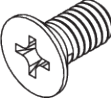
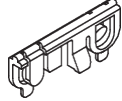
	<b>SG 2004</b> Bottom bar 20x7 mm
	<b>SG 2539</b> Tape
	<b>SG 3003</b> Clamp
	<b>SG 10123</b> Profile 3-channel
	<b>SG 10143</b> Cover
	<b>SG 10159</b> Countersunk head screw 3.5x13
	<b>SG 10200</b> 2C roller
	<b>SG 10230</b> Carrier alu
	<b>SG 10252</b> End cover left
	<b>SG 10253</b> End cover right

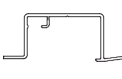
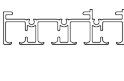
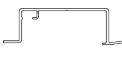
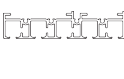
## B. OPTIONAL PARTS

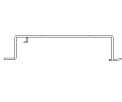
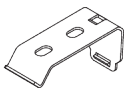
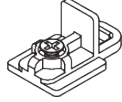
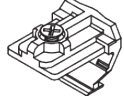
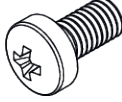
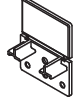
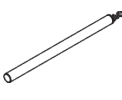
	<b>SG 2005</b> Bottom bar 40x5 mm		<b>SG 10144</b> End cover
	<b>SG 3004</b> Clamp		<b>SG 10145</b> End cover
	<b>SG 3008</b> Connection bridge		<b>SG 10146</b> Angle
	<b>SG 6024</b> Connection bridge		<b>SG 10148</b> Eyelet for draw rod
	<b>SG 6149</b> Safety glider blue		<b>SG 10156</b> End stop
	<b>SG 6245</b> Spring stop		<b>SG 10157</b> Wedge
	<b>SG 10074</b> Countersunk head screw M4x8		<b>SG 10158</b> Click glider
	<b>SG 10122</b> Profile 2-channel		<b>SG 10172</b> Recess profile 2-channel
	<b>SG 10124</b> Profile 4-channel		<b>SG 10173</b> Recess profile 3-channel
	<b>SG 10125</b> Profile 5-channel		<b>SG 10174</b> Recess profile 4-channel
	<b>SG 10136</b> Bracket		<b>SG 10175</b> Recess profile 5-channel
	<b>SG 10137</b> Bracket		<b>SG 10340</b> Eyelet for draw rod
	<b>SG 10140</b> Angle		<b>SG 10395</b> Pan head screw M4x6
	<b>SG 10142</b> End cover		<b>SG 10430</b> Draw rod 50 cm



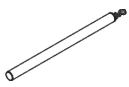

**SG 10431**

*Draw rod 75 cm*

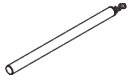

**SG 10432**

*Draw rod 100 cm*

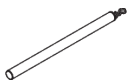

**SG 10433**

*Draw rod 125 cm*

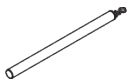

**SG 10434**

*Draw rod 150 cm*



**SG 10492**

*Pan head screw M4x8*

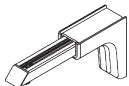

**SG 11154**

*Universal Smart Fix 120 mm*

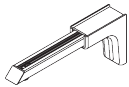

**SG 11155**

*Universal Smart Fix 150 mm*

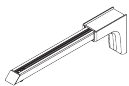

**SG 11156**

*Universal Smart Fix 200 mm*

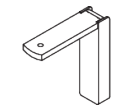

**SG 11200**

*Smart Fix 60 mm*

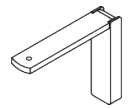

**SG 11201**

*Smart Fix 80 mm*

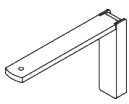

**SG 11202**

*Smart Fix 100 mm*

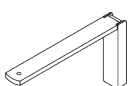

**SG 11203**

*Smart Fix 120 mm*

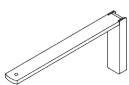

**SG 11204**

*Smart Fix 150 mm*

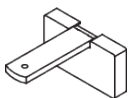

**SG 11210**

*Square Smart Fix 60 mm*

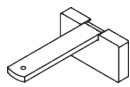

**SG 11211**

*Square Smart Fix 80 mm*

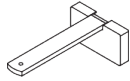

**SG 11212**

*Square Smart Fix 100 mm*

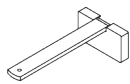

**SG 11213**

*Square Smart Fix 120 mm*

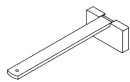

**SG 11214**

*Square Smart Fix 150 mm*





