

# SG 7610

---

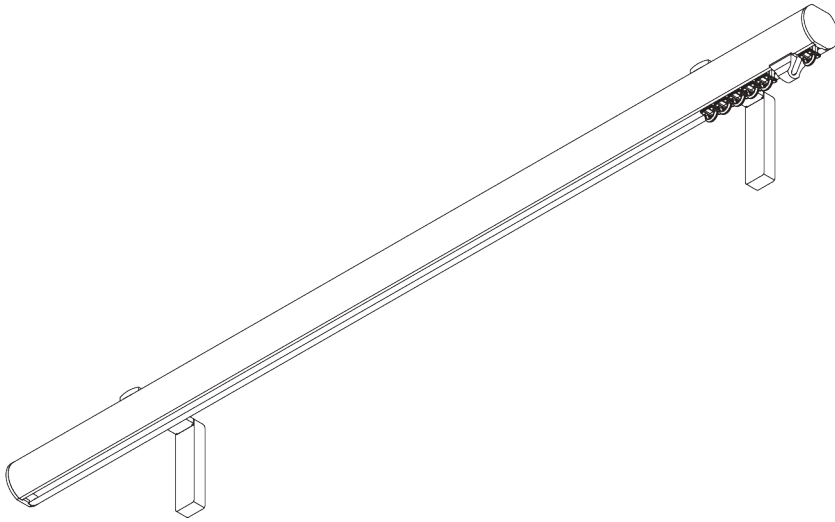
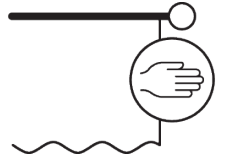

## PRODUCT INFORMATION

- **Operation:** hand
- **Range:** S - M
- **Fitting:** ceiling, wall
- **Colours:** white RAL 9016, various colours / finishes
- **Fabrics:** refer to Silent Gliss fabric collection

### **Features:**

- 2-component (2C) glider technology
- Wave (2C)
- Matching endcaps and brackets / bracket covers
- Range of decorative finials
- Bendable

# SYSTEM SPECIFICATIONS

## A. PROFILE

Profile and bending information

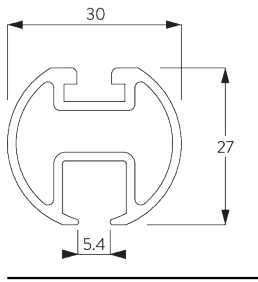

SG 6103p

Profile



## B. HOW TO MEASURE

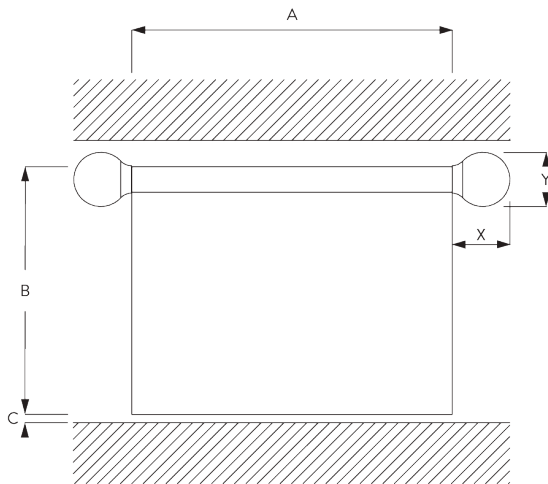

A: System width without finials







B: System height

C: Distance between floor and fabric

X: Finial width

Y: Finial height

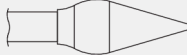
## Finial Measurements

		30 mm	
		X	Y
	SG 11603	2	30
	SG 11631	10	34
	SG 11632	18	50
	SG 11746	64	60
	SG 11747	116	48
	SG 11748	26	90
	SG 11749	20	60

# FITTING

## A. FITTING INFORMATION

For detailed fitting information, visit the *Silent Gliss* website.

### Fixing points

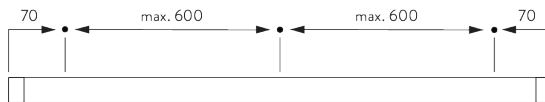

## B. CEILING FITTING

### Top fix bracket SG 11668

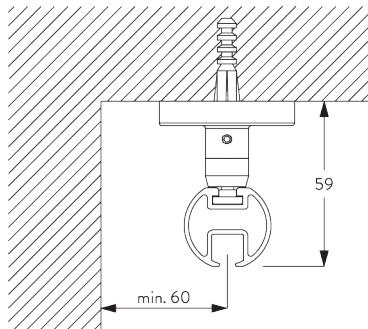



**SG 11668**  
Top fix bracket

**Mini hanger SG 6175**

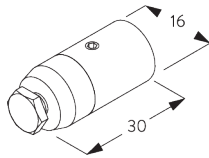
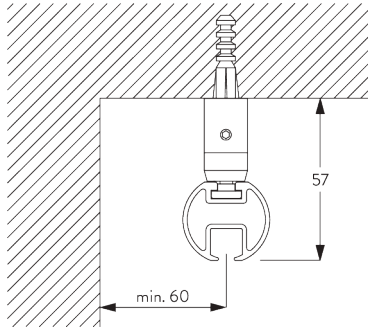

**SG 6175**  
Mini hanger

**C. WALL FITTING**

**Smart Fix**

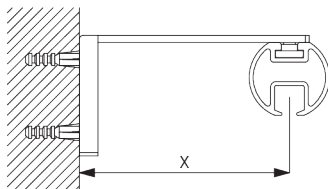

**Smart Fix with slot SG 11206 - SG 11208 and SG 6141:**  
Screw SG 10492 (M4x8) needed.

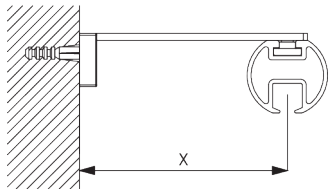

**Square Smart Fix with slot SG 11216 - SG 11218 and SG 6141:**  
Screw SG 10492 (M4x8) needed.

Smart Fix	X mm
SG 11206 / SG 11216	51
SG 11207 / SG 11217	71
SG 11208 / SG 11218	91

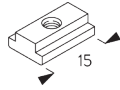

**SG 6141**  
Clamping piece



**SG 10492**  
Pan head screw M4x8

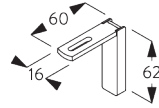

**SG 11206**  
Smart Fix with slot 60 mm

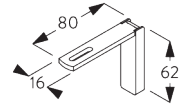

**SG 11207**  
Smart Fix with slot 80 mm

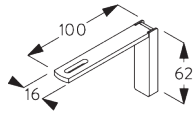

**SG 11208**  
Smart Fix with slot 100 mm

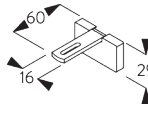

**SG 11216**  
Square Smart Fix with slot 60 mm

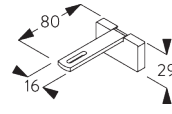

**SG 11217**  
Square Smart Fix with slot 80 mm

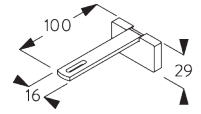

**SG 11218**  
Square Smart Fix with slot 100 mm

## Fillet Bracket SG 11669

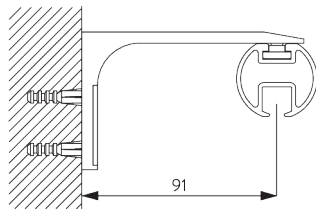

Screw SG 10492 (M4x8) needed.  
Recommended for straight systems only.

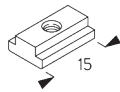

**SG 6141**  
Clamping piece



**SG 10492**  
Pan head screw M4x8

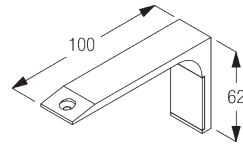

**SG 11669**  
Fillet bracket

# DESIGN & SYSTEM OPTIONS

## A. ENDCAPS



SG 11603



SG 11631



SG 11632

Endcaps:

- SG 11603 Flush endcap 30 mm
- SG 11631 Stud endcap 30 mm
- SG 11632 Design endcap 30 mm

Please note:

- Without finials, poles are supplied as standard with flush fitting endcaps SG 11603 (left).
- Alternatively, stud endcaps SG 11631 can be selected.

## B. FINIALS

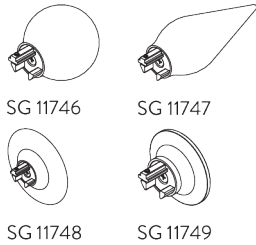

Finials are decorative elements that fit on at the end of the pole:

- SG 11746 Ball end 30 mm
- SG 11747 Spear 30 mm
- SG 11748 Ellipse 30 mm
- SG 11749 Taper 30 mm

## C. WAVE

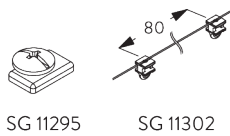
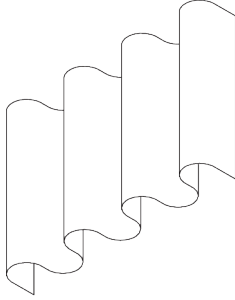

Standard components:

- SG 11295 End stop
- SG 11302 Wave 2C glider cord 80 mm

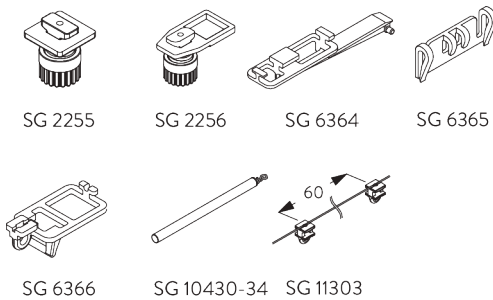

Optional components:

- SG 2255 Brake
- SG 2256 Brake
- SG 6364 Wave extension
- SG 6365 Wave hanger
- SG 6366 Wave carrier for draw rod
- SG 10430-34 Draw rod
- SG 11303 Wave 2C glider cord 60 mm

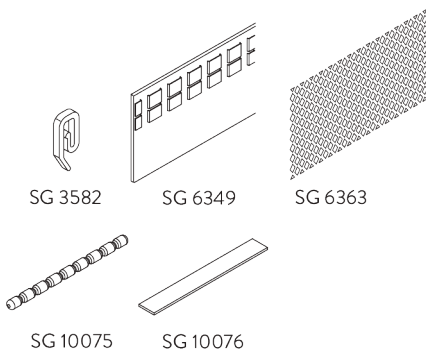

Curtain components:

- SG 3582 Hook
- SG 6349 Wave curtain tape
- SG 6363 Wave top hemming tape
- SG 10075 Lead weight 50 gr/m
- SG 10076 Fabric weigh

Wave stack depth - 2C glider cord (standard components)

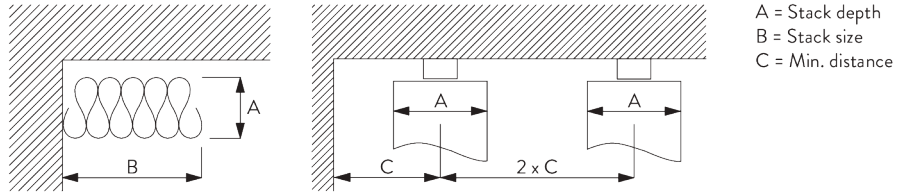









2C Glider cord SG 11302	Pockets between hooks	Approx. curtain fullness	Stack depth A	Stack size B*	Min distance C
80	6	~2.1	140	180 per metre of track	90
80	7	~2.3	160	180 per metre of track	100

2C Glider cord SG 11303	Pockets between hooks	Approx. curtain fullness	Stack depth A	Stack size B*	Min distance C
60	4	~2.1	100	230 per metre of track	70
60	5	~2.3	120	230 per metre of track	80

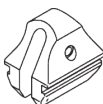

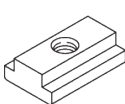

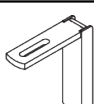





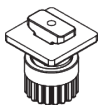
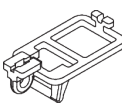
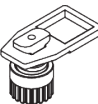
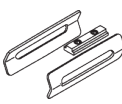



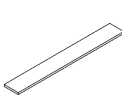

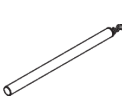

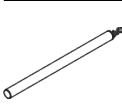
\*Stack size B when using optional extension arm SG 6364 increases by 95 mm per curtain stack!

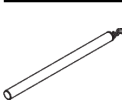
# PARTS

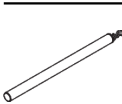
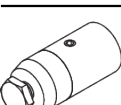
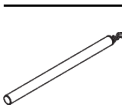
## A. STANDARD PARTS

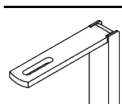
	<b>SG 3599</b> Hook
	<b>SG 6065</b> End stop
	<b>SG 6086</b> Spring stop
	<b>SG 6103p</b> Profile
	<b>SG 6141</b> Clamping piece
	<b>SG 10492</b> Pan head screw M4x8
	<b>SG 11206</b> Smart Fix with slot 60 mm
	<b>SG 11300</b> 2C glider
	<b>SG 11603</b> Flush end cap 30 mm

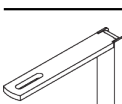
## B. OPTIONAL PARTS

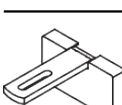
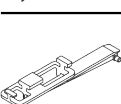
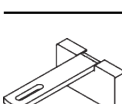
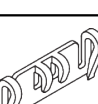
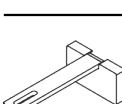
	<b>SG 2255</b> Brake		<b>SG 6366</b> Wave carrier for draw rod
	<b>SG 2256</b> Brake		<b>SG 6635</b> Connection bridge set
	<b>SG 3012</b> Hook		<b>SG 10075</b> Lead weight 50 g/m
	<b>SG 3582</b> Hook		<b>SG 10076</b> Fabric weight
	<b>SG 6057</b> Glider		<b>SG 10430</b> Draw rod 50 cm
	<b>SG 6082</b> Glider		<b>SG 10431</b> Draw rod 75 cm
	<b>SG 6094</b> Roller		<b>SG 10432</b> Draw rod 100 cm
	<b>SG 6098</b> Roller		<b>SG 10433</b> Draw rod 125 cm
	<b>SG 6175</b> Mini hanger		<b>SG 10434</b> Draw rod 150 cm
	<b>SG 6283</b> Roller		<b>SG 11207</b> Smart Fix with slot 80 mm
	<b>SG 6349</b> Wave curtain tape		<b>SG 11208</b> Smart Fix with slot 100 mm
	<b>SG 6363</b> Wave top hemming tape		<b>SG 11216</b> Square Smart Fix with slot 60 mm
	<b>SG 6364</b> Wave extension		<b>SG 11217</b> Square Smart Fix with slot 80 mm
	<b>SG 6365</b> Wave hanger		<b>SG 11218</b> Square Smart Fix with slot 100 mm



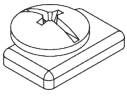

**SG 11295**

*End stop*



**SG 11301**

*2C glider on strip*



**SG 11302**

*Wave 2C glider cord 80 mm*

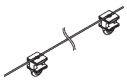

**SG 11303**

*Wave 2C glider cord 60 mm*

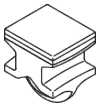

**SG 11305**

*2C glider for direct sewing*



**SG 11631**

*Stud endcap 30 mm*



**SG 11632**

*Design endcap 30 mm*



**SG 11668**

*Top fix bracket*

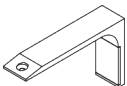

**SG 11669**

*Fillet bracket*

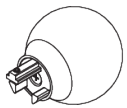

**SG 11746**

*Ball end 30 mm*



**SG 11747**

*Spear 30 mm*

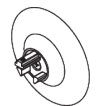

**SG 11748**

*Ellipse 30 mm*

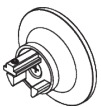

**SG 11749**

*Taper 30 mm*





