

# SG 4910

---

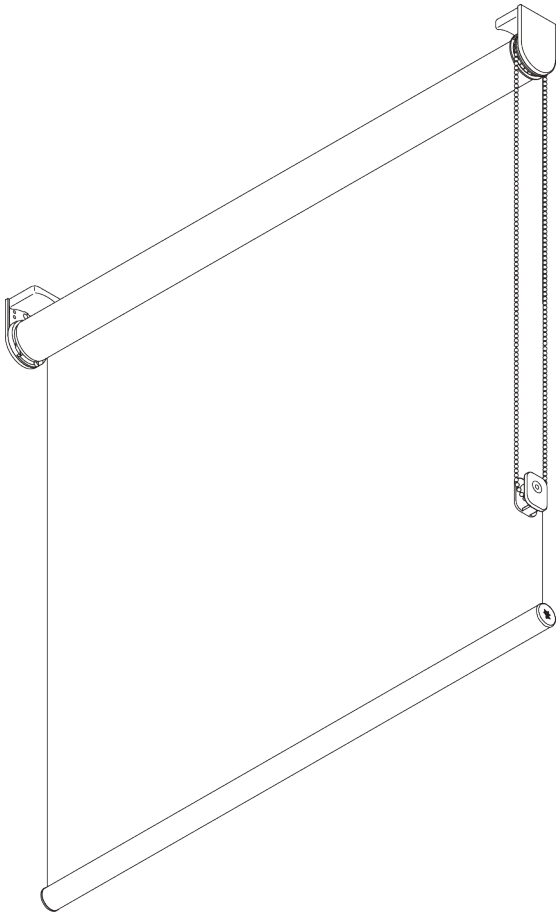
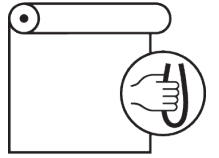

## PRODUCT INFORMATION

- **Operation:** chain
- **Range:** S - M
- **Fitting:** ceiling, wall, recess
- **Colours:** white RAL 9016, grey RAL 7035, black RAL 9005; special colours possible
- **Fabrics:** refer to Silent Gliss fabric collection

### **Features:**

- Spring assisted, effortless operation
- 1-to-1 gear drive
- Stainless steel bead chain
- Click-in brackets
- Fascia, box, installation profile
- 04E202402 controller

# SYSTEM SPECIFICATIONS

## A. SYSTEM DIMENSIONS



2.4 m



25 cm\*,  
Fascia / Box: 60 cm  
\*25 - 60 cm only with  
installation profile  
SG 10534

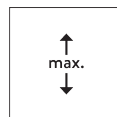

3 m

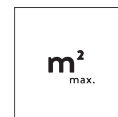

7.2 m<sup>2</sup>



3 kg

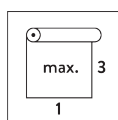

Recommended width /  
height ratio  
max. 1:3

## Maximum system drop

Wall fitting (system drop on window side):

Fabric thickness	mm	0.15	0.20	0.25	0.30	0.35	0.40	0.45	0.50	0.55	0.60	0.65	0.70	0.75	0.80
Max. system drop	cm	300	300	300	300	300	300	300	300	300	290	270	250	230	220

Ceiling fitting / wall fitting (system drop on room side):

Fabric thickness	mm	0.15	0.20	0.25	0.30	0.35	0.40	0.45	0.50	0.55	0.60	0.65	0.70	0.75	0.80
Max. system drop	cm	300	300	300	300	300	300	300	300	300	300	300	300	300	280

## B. PROFILE

### Profile information

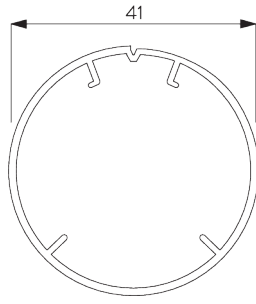

**SG 10531**  
Tube ø 41 mm



**SG 10760**  
Bottom bar

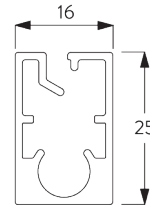

**SG 10770**  
Bottom bar

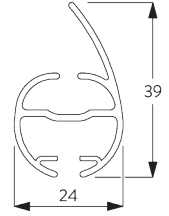

**SG 4903**  
Bottom bar

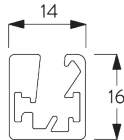

**SG 11442**  
Bottom bar

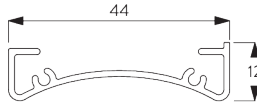

**SG 10534**  
Installation profile

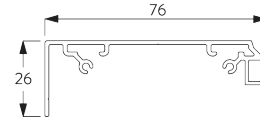

**SG 11430**  
Installation profile fascia 73 mm

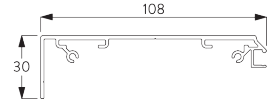

**SG 11530**  
Installation profile fascia 110 mm

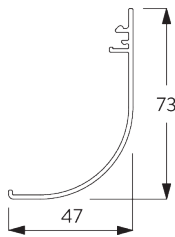

**SG 11431**  
Fascia round 73 mm

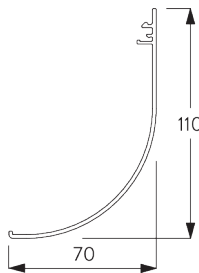

**SG 11531**  
Fascia round 110 mm

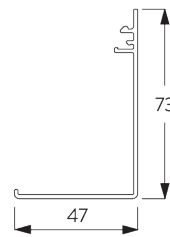

**SG 11432**  
Fascia square 73 mm

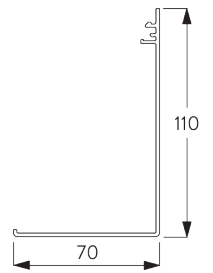

**SG 11532**  
Fascia square 110 mm

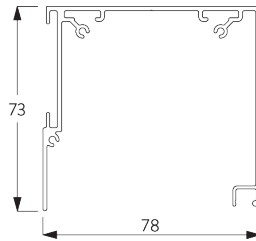

**SG 11433**  
Box case 73 mm

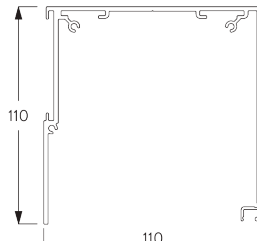

**SG 11533**  
Box case 110 mm

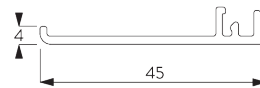

**SG 11434**  
Box cover 73 mm



**SG 11534**  
Box cover 110 mm

## C. HOW TO MEASURE

*incl. bracket covers*

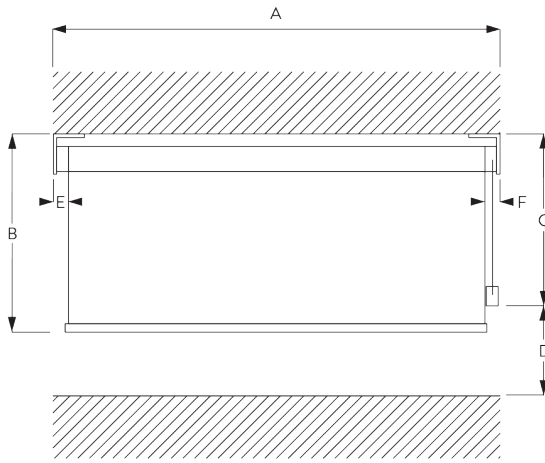

- A: System width
- B: System height
- C: Chain height
- D: Safety Retainer SG 10731 min. 150 cm above floor
- E: Light gap: 13 mm
- F: Light gap operation side: 18 mm

Note:

All measurements include 2 mm for bracket cover per side!

## Fascia / Box

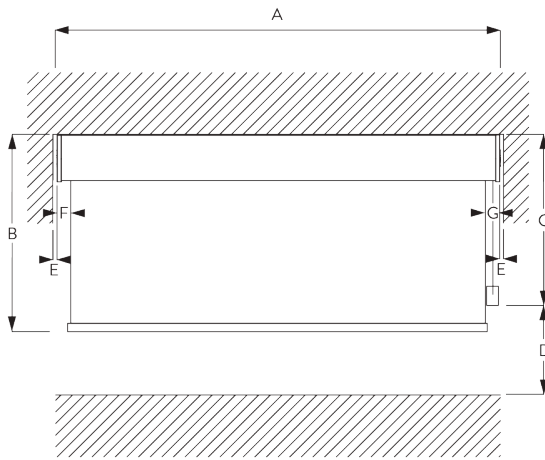

- A: System width
- B: System height
- C: Chain height
- D: Safety Retainer SG 10731 min. 150 cm above floor
- E: Gap: min. 10 mm (when cover is used)
- F: Light gap: 15 mm
- G: Light gap operation side: 21 mm

# FITTING

## A. FITTING INFORMATION

For detailed fitting information, visit the [Silent Gliss website](#).

### Fixing points



Brackets (wall / ceiling)

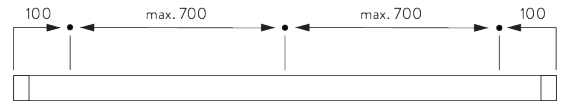

Fascia / box & installation profile SG 10534 (wall / ceiling)

## **B. CEILING FITTING**

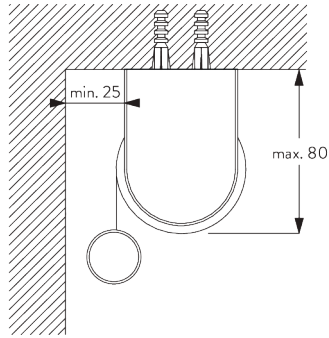

**Brackets**

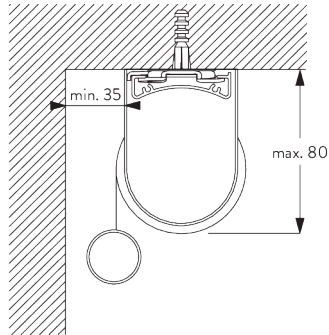

**Installation profile SG 10534 and clamps SG 3033 or SG 3044**

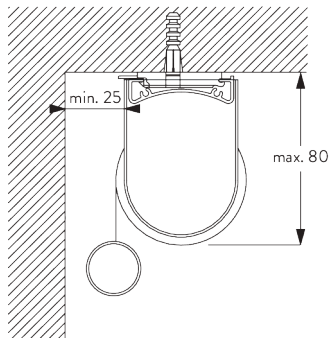

**Installation profile SG 10534 and click bracket SG 10539**

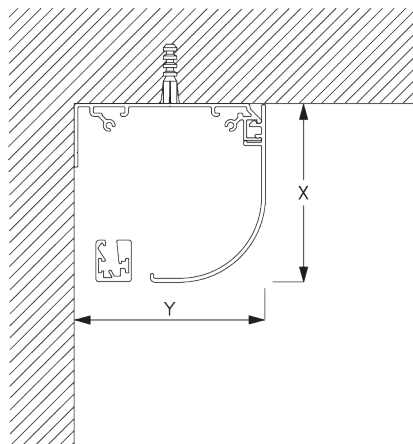

**Fascia round**

X = Fascia S 73 mm / Fascia L 110 mm

Y = Fascia S 78 mm / Fascia L 110 mm

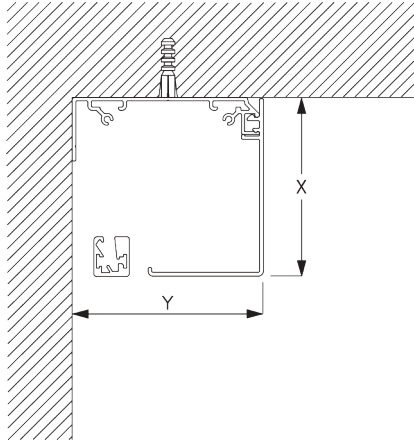

**Fascia square**

X = Fascia S 73 mm / Fascia L 110 mm

Y = Fascia S 78 mm / Fascia L 110 mm

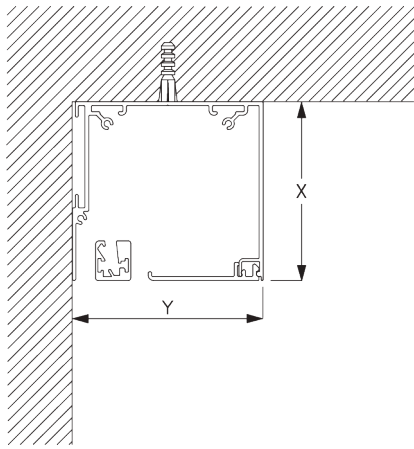

**Box**

X = Box S 73 mm / Box L 110 mm

Y = Box S 78 mm / Box L 110 mm

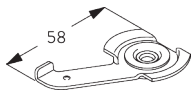

**SG 3033**

Clamp

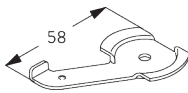

**SG 3044**

Clamp

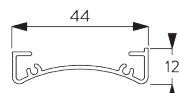

**SG 10534**

Installation profile

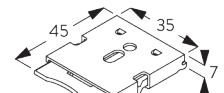

**SG 10539**

Bracket

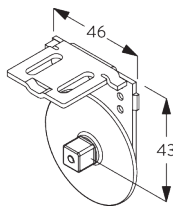

**SG 10542**

Bracket

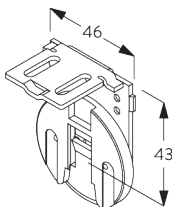

**SG 10543**

Bracket



**SG 10574**

Bracket cover

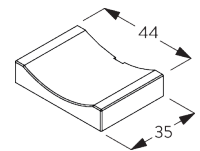

**SG 10575**

Bracket cover

## C. WALL FITTING

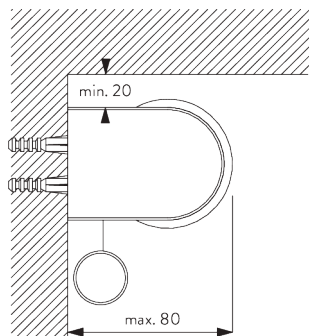

**Brackets**

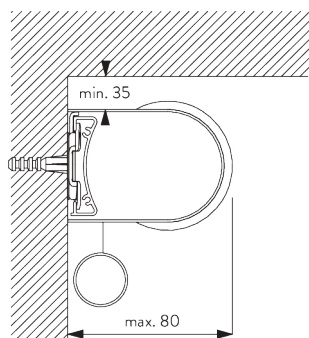

**Installation profile SG 10534 and clamps SG 3033 or SG 3044**

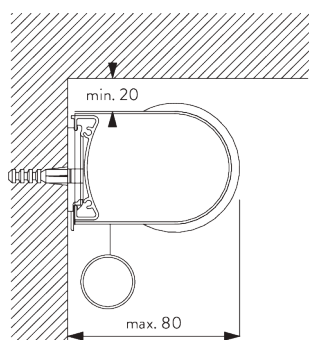

**Installation profile SG 10534 and click bracket SG 10539**

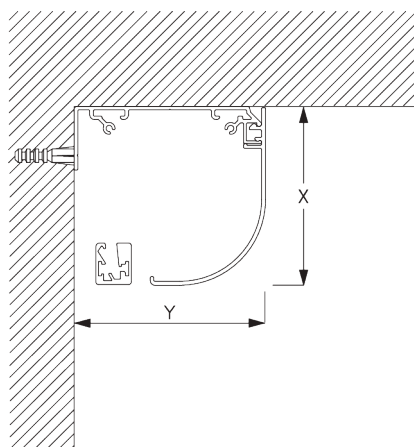

**Fascia round**

X = Fascia S 73 mm / Fascia L 110 mm

Y = Fascia S 78 mm / Fascia L 110 mm

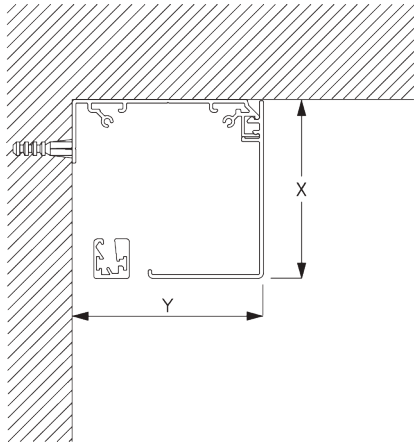

**Fascia square**

X = Fascia S 73 mm / Fascia L 110 mm

Y = Fascia S 78 mm / Fascia L 110 mm

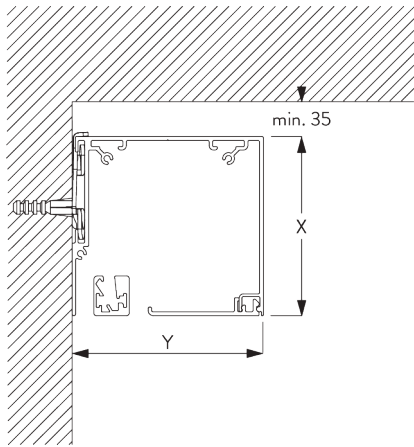

**Box S and clamp SG 3044 / Box L and clamp SG 11180**

X = Box S 73 mm / Box L 110 mm

Y = Box S 78 mm / Box L 110 mm

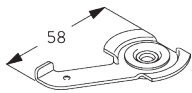

**SG 3033**

Clamp

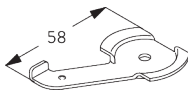

**SG 3044**

Clamp

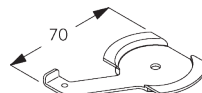

**SG 11180**

Clamp

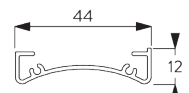

**SG 10534**

Installation profile

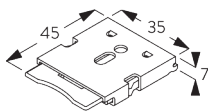

**SG 10539**

Bracket

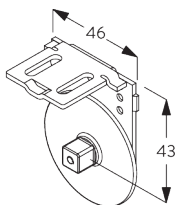

**SG 10542**

Bracket

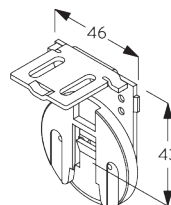

**SG 10543**

Bracket

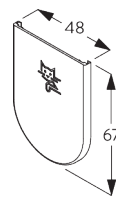

**SG 10574**

Bracket cover



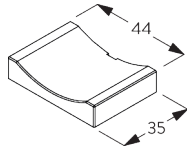

**SG 10575**  
Bracket cover

**D. RECESS FITTING**

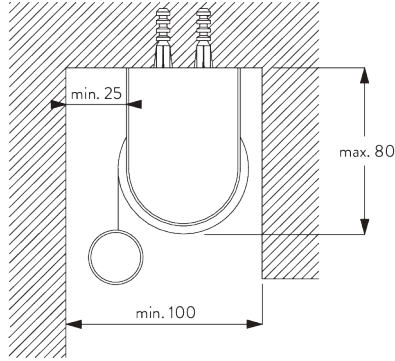

**Brackets**

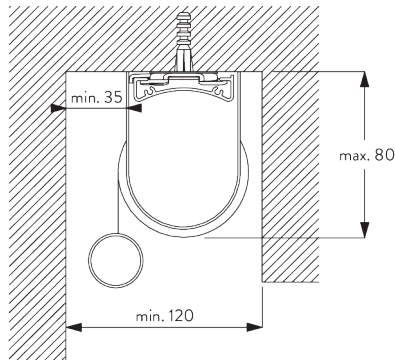

**Installation profile SG 10534 and clamps SG 3033 or SG 3044**

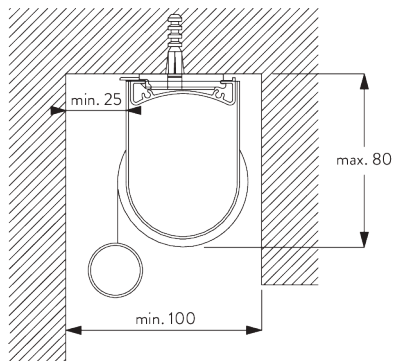

**Installation profile SG 10534 and click bracket SG 10539**

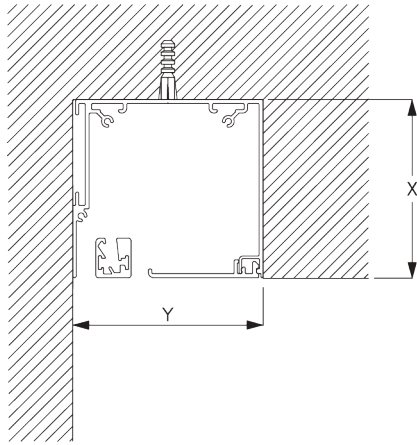

**Box**

X = Box S 73 mm / Box L 110 mm

Y = Box S min. 79 mm / Box L min. 111 mm

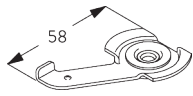

**SG 3033**

Clamp

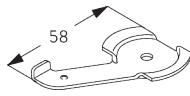

**SG 3044**

Clamp

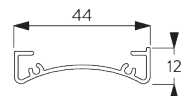

**SG 10534**

Installation profile

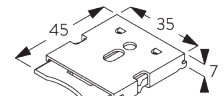

**SG 10539**

Bracket

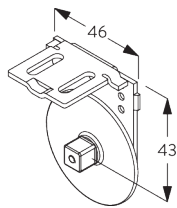

**SG 10542**

Bracket

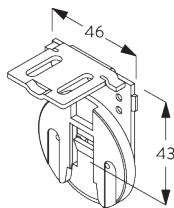

**SG 10543**

Bracket



**SG 10574**

Bracket cover

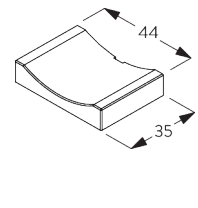

**SG 10575**

Bracket cover

**E. FITTING WITH  
SIDE GUIDE  
OPTION**

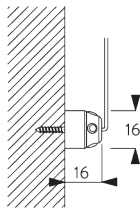
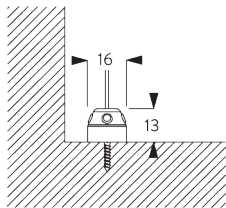

**Single system**

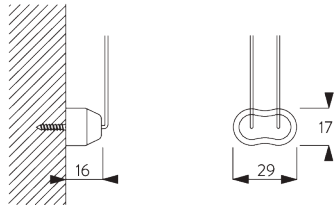
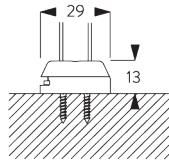

**Double system (side-by-side installation)**

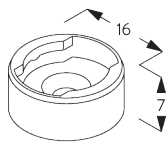

**SG 8235**  
Side guide wire base short

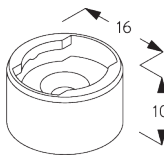

**SG 8236**  
Side guide wire base long

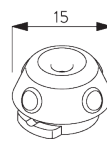

**SG 8237**  
Side guide wire holder

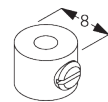

**SG 8249**  
Side guide device

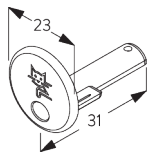

**SG 10762**  
Side guide end cover

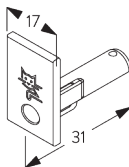

**SG 10772**  
Side guide end cover

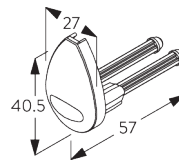

**SG 4944**  
Side guide end cover

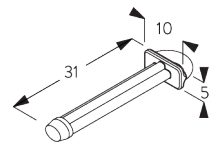

**SG 10641**  
Side guide eyelet

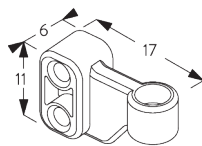

**SG 10642**  
Side guide wire holder

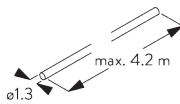

**SG 10643**  
Side guide wire ø 1.3 mm x 4.2 m

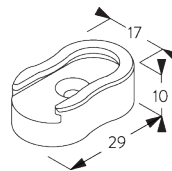

**SG 10669**  
Side guide double base long

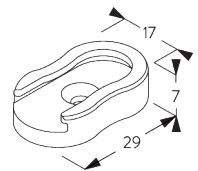

**SG 10673**  
Side guide double base short

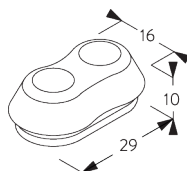

**SG 10701**  
Side guide double wire holder

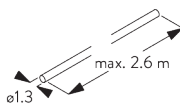

**SG 10706**  
Side guide wire ø 1.3 mm x 2.6 m

# SYSTEM OPTIONS

## A. FABRIC ROLL-OFF

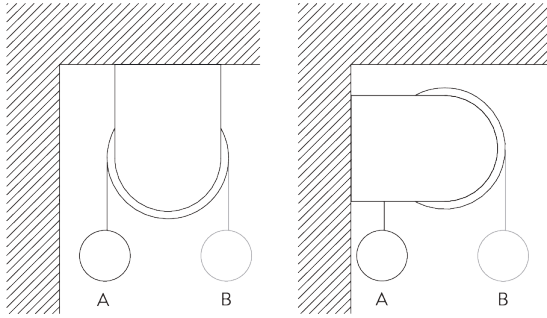

A: Fabric roll-off window side (standard)  
B: Fabric roll-off room side (option)

## B. INSTALLATION PROFILE

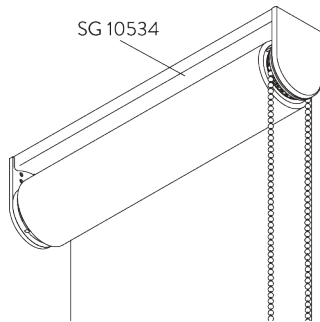

## C. ADJUSTABLE END STOP

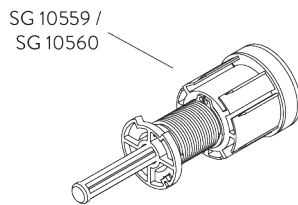

Setting of upper or lower end position.

## D. SIDE GUIDES

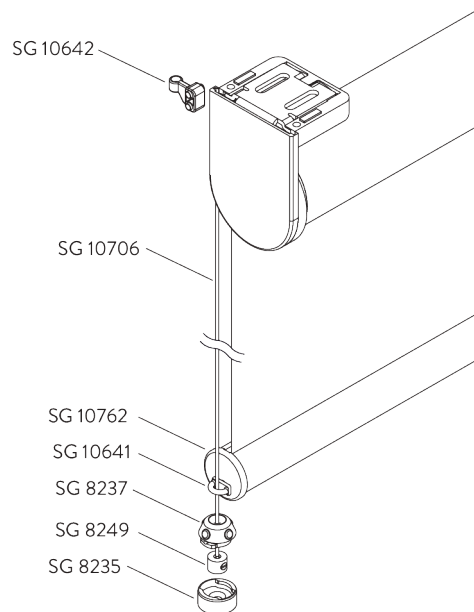

### Additional parts:

- 2x SG 8235 Side guide wire base short
- 2x SG 8237 Side guide wire holder
- 2x SG 8249 Side guide device
- 2x SG 10762 Side guide end cover round
- 2x SG 10641 Side guide eyelet
- 2x SG 10642 Side guide wire holder
- 2x SG 10706 Side guide wire  $\varnothing$  1.3 mm x 2.6 m

### Optional parts:

- 2x SG 8236 Side guide wire base long
- 2x SG 10772 Side guide end cover square
- 2x SG 10643 Side guide wire  $\varnothing$  1.3 mm x 4.2 m
- 1x SG 10669 Side guide double base long
- 1x SG 10673 Side guide double base short
- 1x SG 10701 Side guide double wire holder

### Note:

- Light gaps increase when side-guide option is used
- Up to 15° from vertical

## E. TWO SINGLE SYSTEMS SIDE-BY-SIDE

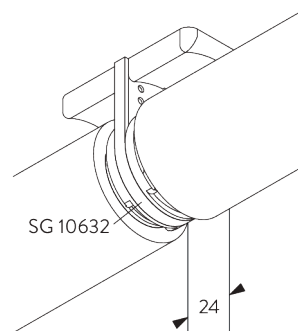

### Additional parts:

- 1x SG 10632 Connection bracket cover

## F. CHILD SAFETY

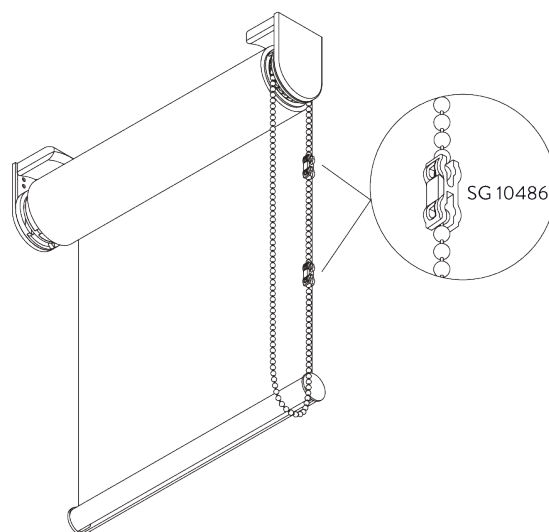

The chain break connector SG 10486 releases the chain should the pulling force exceed 6 kg.

### Note:

- System to be installed so chain loop ends at least 60 cm above floor.

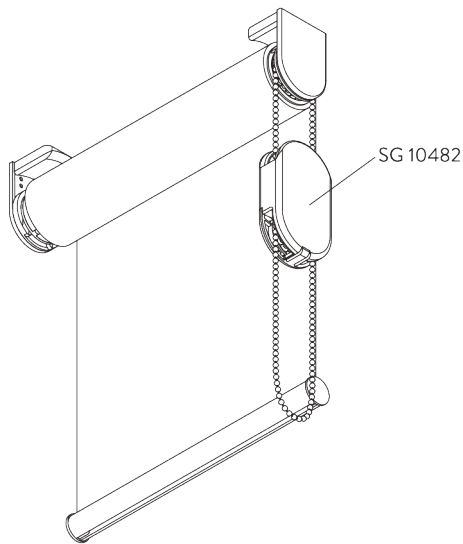

The child safety device SG 10482 releases the chain should the pulling force exceed 6 kg.

Note:

- System to be installed so chain loop of child safety device ends at least 60 cm above floor.

## **G. FASCIA / BOX**

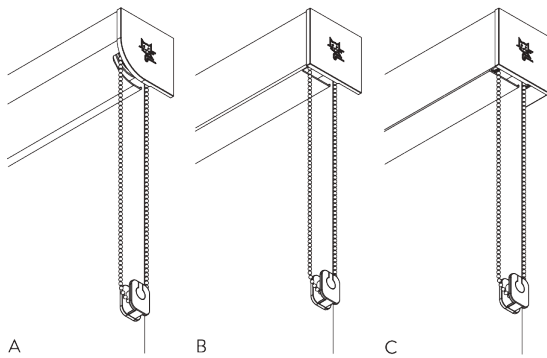

- A: Fascia round
- B: Fascia square
- C: Box

Size:

- S: 78 x 73 mm
- L: 110 x 110 mm

Note:

- Only applicable with bottom bar SG 11442

# PARTS

## A. STANDARD PARTS

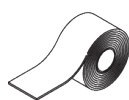

**SG 4226**  
Double tape 30 mm



**SG 10530**  
Bead chain metal ø 4 mm

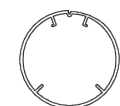

**SG 10531**  
Tube ø 41 mm



**SG 10542**  
Bracket

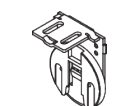

**SG 10543**  
Bracket



**SG 10547**  
Spring C left, 641 mm

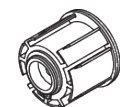

**SG 10556**  
Tube adapter



**SG 10574**  
Bracket cover

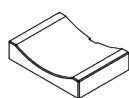

**SG 10575**  
Bracket cover



**SG 10668**  
PVC strip 10 mm



**SG 10731**  
Child safety retainer set



**SG 10760**  
Bottom bar



**SG 10761**  
End cover



**SG 3033**  
Clamp



**SG 3044**  
Clamp



**SG 4903**  
Bottom bar



**SG 8235**  
Side guide wire base short

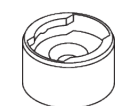

**SG 8236**  
Side guide wire base long



**SG 8237**  
Side guide wire holder

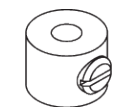

**SG 8249**  
Side guide device

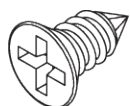

**SG 10139**  
Countersunk screw 2.9x6.5

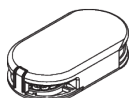

**SG 10482**  
Child safety device set metal chain ø 4.0 mm

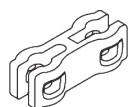

**SG 10486**  
Child safety chain break connector set

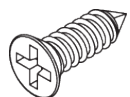

**SG 10498**  
Countersunk screw 2.9x9.5



**SG 10534**  
Installation profile

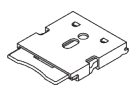

**SG 10539**  
Bracket



**SG 10545**  
Spring A left, 420 mm



**SG 10546**  
Spring B left, 487 mm



**SG 10548**  
Spring D left, 721 mm

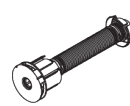

**SG 10549**  
Spring E left, 824 mm

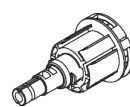

**SG 10550**  
Chain drive

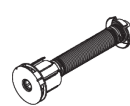

**SG 10551**  
Spring A right, 420 mm

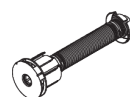

**SG 10552**  
Spring B right, 487 mm

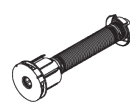

**SG 10553**  
Spring C right, 641 mm



**SG 10554**  
Spring D right, 721 mm

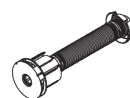

**SG 10555**  
Spring E right, 824 mm

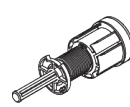

**SG 10559**  
End stop left threads

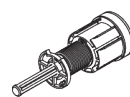

**SG 10560**  
End stop right threads





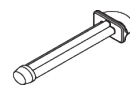







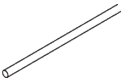
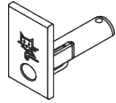
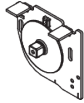





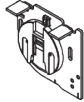
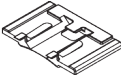

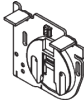





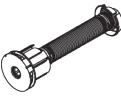
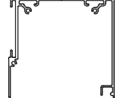

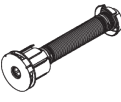

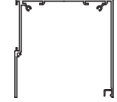



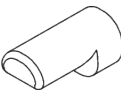

**SG 10632**  
Connection bracket cover



**SG 10641**  
Side guide eyelet

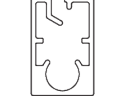

**SG 10642**  
Side guide wire holder

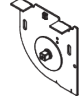
	<b>SG 10643</b> Side guide wire $\varnothing$ 1.3 mm x 4.2 m		<b>SG 10772</b> Side guide end cover		<b>SG 11446</b> Bracket left 73 mm
	<b>SG 10669</b> Side guide double base long		<b>SG 11178</b> End cover		<b>SG 11447</b> Bracket right 73 mm
	<b>SG 10673</b> Side guide double base short		<b>SG 11180</b> Clamp		<b>SG 11448</b> Bracket left 73 mm
	<b>SG 10690</b> Spacer		<b>SG 11430</b> Installation profile fascia 73 mm		<b>SG 11449</b> Bracket right 73 mm
	<b>SG 10697</b> Spring F left, 921 mm		<b>SG 11431</b> Fascia round 73 mm		<b>SG 11530</b> Installation profile fascia 110 mm
	<b>SG 10698</b> Spring G left, 921 mm		<b>SG 11432</b> Fascia square 73 mm		<b>SG 11531</b> Fascia round 110 mm
	<b>SG 10699</b> Spring F right, 921 mm		<b>SG 11433</b> Box case 73 mm		<b>SG 11532</b> Fascia square 110 mm
	<b>SG 10700</b> Spring G right, 921 mm		<b>SG 11434</b> Box cover 73 mm		<b>SG 11533</b> Box case 110 mm
	<b>SG 10701</b> Side guide double wire holder		<b>SG 11437</b> Bracket cover round left 73 mm		<b>SG 11534</b> Box cover 110 mm
	<b>SG 10706</b> Side guide wire $\varnothing$ 1.3 mm x 2.6 m		<b>SG 11438</b> Bracket cover round right 73 mm		<b>SG 11537</b> Bracket cover round left 110 mm
	<b>SG 10707</b> End stop		<b>SG 11439</b> Bracket cover square left 73 mm		<b>SG 11538</b> Bracket cover round right 110 mm
	<b>SG 10762</b> Side guide end cover		<b>SG 11440</b> Bracket cover square right 73 mm		<b>SG 11539</b> Bracket cover square left 110 mm
	<b>SG 10770</b> Bottom bar		<b>SG 11442</b> Bottom bar		<b>SG 11540</b> Bracket cover square right 110 mm
	<b>SG 10771</b> End cover		<b>SG 11443</b> End cover		<b>SG 11546</b> Bracket left 110 mm





---

**SG 11547**

*Bracket right 110 mm*

---



---

**SG 11548**

*Bracket left 110 mm*

---

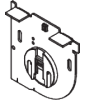

---

**SG 11549**

*Bracket right 110 mm*

---





