

SG 4980

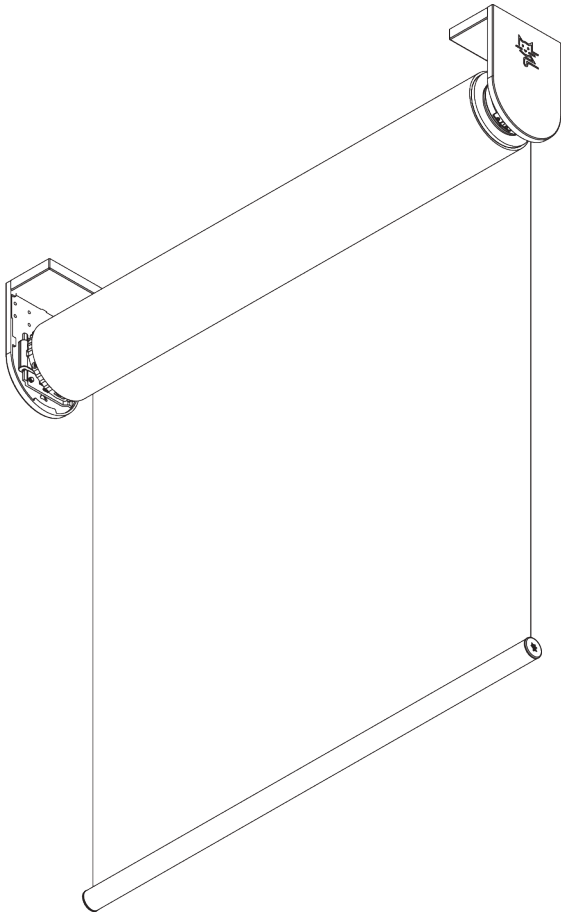
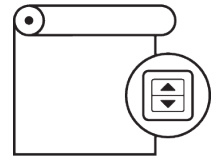

PRODUCT INFORMATION

- **Operation:** motorised
- **Range:** L
- **Fitting:** ceiling, wall, recess
- **Colours:** white RAL 9016, grey RAL 7035, black RAL 9005; special colours possible
- **Fabrics:** refer to Silent Gliss fabric collection

Features:

- Quiet and fast motors
- Soft stop
- Various control options
- Stainless steel brackets, adjustable for vertical alignment of fabric

SYSTEM SPECIFICATIONS

A. SYSTEM DIMENSIONS

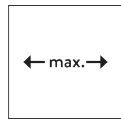

4 m

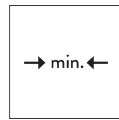

95 cm*

*see motor specification table

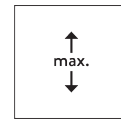

12 m



36 m²



23 kg

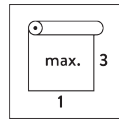

Recommended width / height ratio max. 1:3

Maximum surface area

		A →				
		2 m	2.5 m	3 m	3.5 m	4 m
B ↓	2 m	●	●	●	●	●
	2.5 m	●	●	●	●	●
	3 m	●	●	●	●	●
	3.5 m	●	●	●	●	●
	4 m	●	●	●	●	●
	4.5 m	●	●	●	●	●
	5 m	●	●	●	●	●
	5.5 m	●	●	●	●	●
	6 m	●	●	●	●	●
	6.5 m	●	●	●	●	●
	7 m	●	●	●	●	●
	7.5 m	●	●	●	●	●
	8 m	●	●	●	●	●
	8.5 m	●	●	●	●	●
	9 m	●	●	●	●	●
	9.5 m	●	●	●	●	
10 m	●	●	●	●		
10.5 m	●	●	●			
11 m	●	●	●			
11.5 m	●	●	●			
12 m	●	●	●			

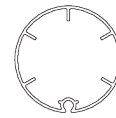

● SG 4929 (ø 80 mm)

max. 36 m²

B. PROFILE

Profile information

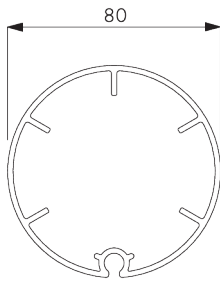

SG 4929
Tube ø 80 mm



SG 10760
Bottom bar

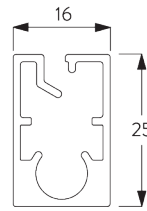

SG 10770
Bottom bar

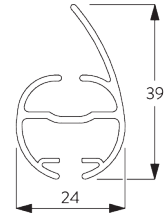

SG 4903
Bottom bar

C. HOW TO MEASURE

incl. bracket covers

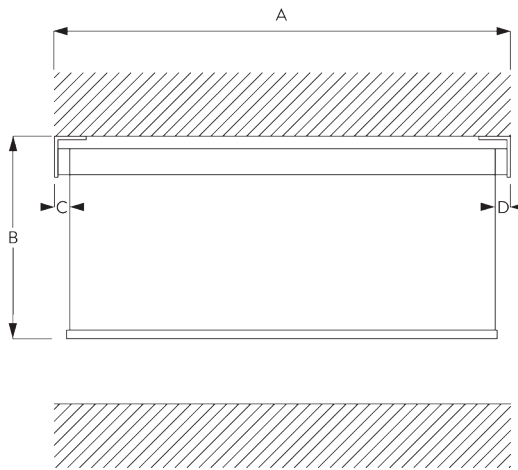

A: System width
B: System height
C: Light gap: 32 mm
D: Light gap operation side: 39 mm

Note:
All measurements include 3 mm for bracket cover per side!

FITTING

A. FITTING INFORMATION

For detailed fitting information, visit the [Silent Gliss website](#).

Fixing points



Adjustable brackets
(for vertical adjustments)

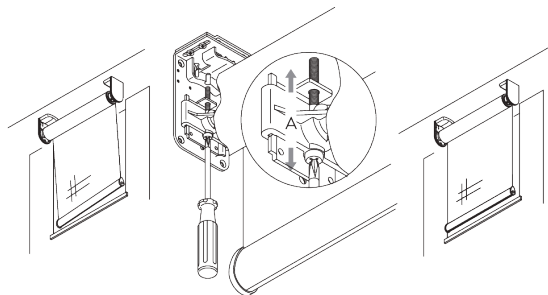

Vertical adjustment of fabric to the window frame.

B. CEILING FITTING

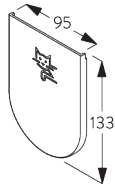
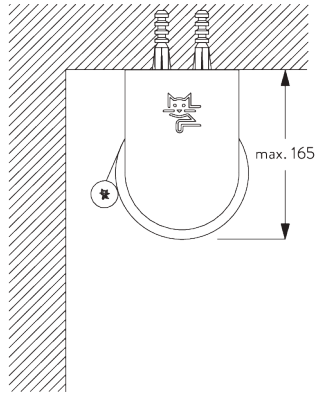

SG 4984
End cover

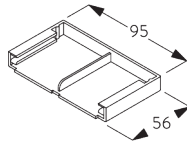

SG 4986
End cover

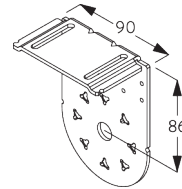

SG 4988
Bracket

C. WALL FITTING

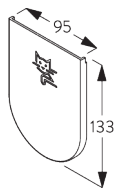
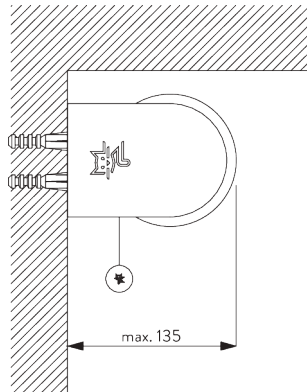

SG 4984
End cover

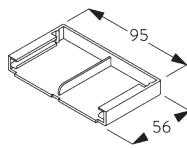

SG 4986
End cover

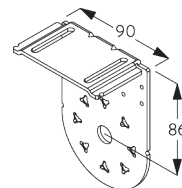

SG 4988
Bracket

D. RECESS FITTING

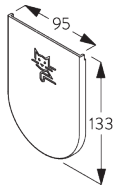
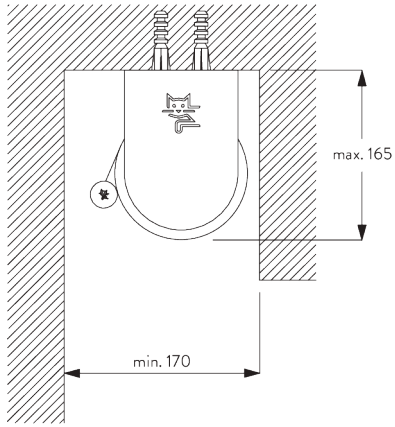

SG 4984

End cover

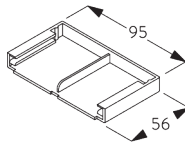

SG 4986

End cover

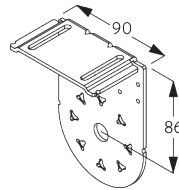

SG 4988

Bracket

E. FITTING WITH SIDE GUIDE OPTION

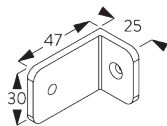
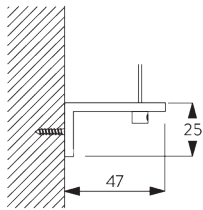

SG 3036

Bracket 47 mm

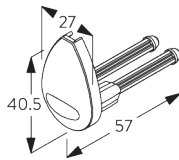

SG 4944

Side guide end cover

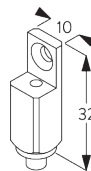

SG 4946

Side guide wire rope fastener

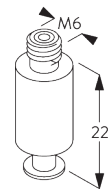

SG 4947

Side guide wire rope fastener

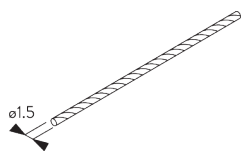

SG 4948

Side guide wire ø 1.5 mm

SYSTEM OPTIONS

A. FABRIC ROLL-OFF

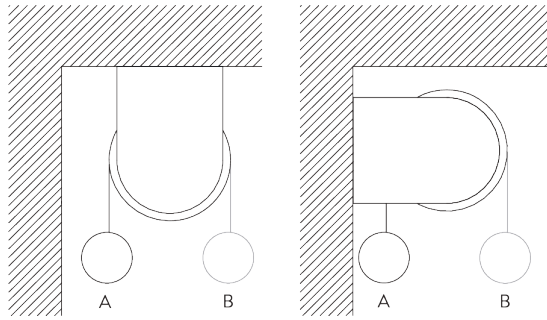

A: Fabric roll-off window side (standard)
B: Fabric roll-off room side (option)

B. SIDE GUIDES

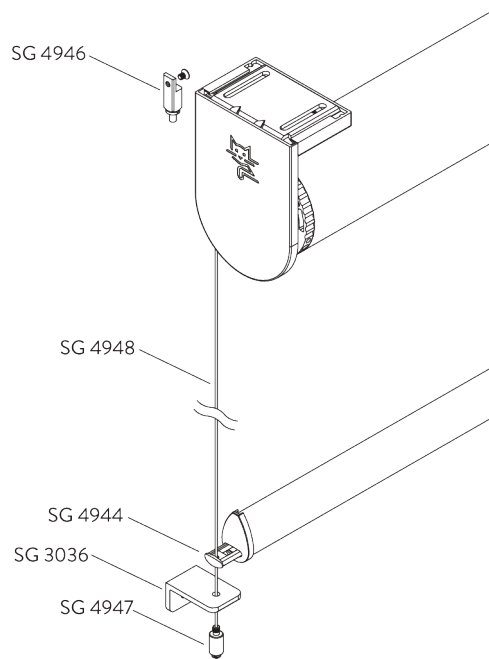

Additional parts:

- 2x SG 3036 Bracket 47 mm
- 2x SG 4944 Side guide end cover
- 2x SG 4946 Side guide wire rope fastener
- 2x SG 4947 Side guide wire rope fastener
- 2x SG 4948 Side guide wire \varnothing 1.5 mm

Note:

- Up to 15° from vertical

MOTORS & CONTROLS

A. MOTOR FEATURES

Motors	50-Series	40-Series	25-Series
	SG 11255	SG 11947 SG 11948	SG 11725
Motor Features			
Soft stop	●	●	●
Electronic end-stop	●	●	●
Electronic revolution counter (unlimited revolution)	●	●	●
One intermediate position possible		●	
Bottom bar alignment	●	●	●*
Parallel wiring possible without additional relays		●	●
Disconnectable motor cable	●	●	●
Motor head white / black / grey	● / - / -	● / ● / -	● / ● / -
IP class	IP 30	IP 30	IP 30
Control Features			
Mains power control			●
Dry contact control		●	
Dry contact and / or SG Control N control		●	
SG Control N (built-in receiver)		●	
Smart by Silent Gliss	●		
Suitable for most major home automation systems (with suitable interface)		●	●

*Based on blinds the same size and fabric

B. MOTOR SPECIFICATIONS

Motors	Light gaps C / D = driving side	Min. system width	Voltage	Current	Frequency	Speed	Frequency receiver
50-Series (Smart by Silent Gliss)							
SG 11255	C: 32 mm / D: 39 mm	70 cm	24 V DC	3 A	n/a	20 rpm	n/a
40-Series							
SG 11947	C: 32 mm / D: 39 mm	95 cm	100-240 V AC	1.1 A	50-60 Hz	20 rpm	433 MHz
SG 11948	C: 32 mm / D: 39 mm	70 cm	24 V DC	3 A	n/a	20 rpm	433 MHz
25-Series							
SG 11725 (standard)	C: 32 mm / D: 39 mm	95 cm	100-240 V AC	1.1 A	50-60 Hz	20 rpm	n/a

C. OPERATING METHODS

See catalogue "controls" for details.

Wall Switch



System can be operated by fixed wall switch.

SG Control N



Various radio hand-held and wall transmitters available.



Silent Gliss Move App.

Smart by Silent Gliss



Open designed two-way communication system which allows to flawlessly integrate products with most major building management systems.









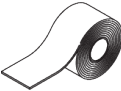
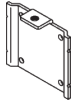

D. WIRING
DIAGRAMS

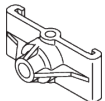

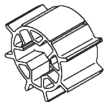
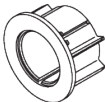

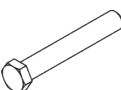

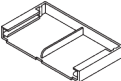

Refer to Silent Gliss website.

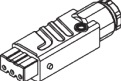
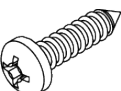
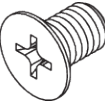



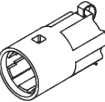

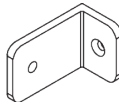

PARTS

A. STANDARD PARTS

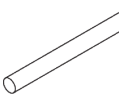
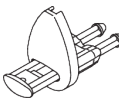
	SG 4223 PVC strip 14 mm
	SG 4226 Double tape 30 mm
	SG 4906 Plate (set SG 4949)
	SG 4914 Tube adapter
	SG 4915 Support
	SG 4926 Motor flange
	SG 4927 Motor drive
	SG 4928 Tube adapter
	SG 4929 Tube ø 80 mm
	SG 4939 Shaft
	SG 4984 End cover
	SG 4986 End cover
	SG 4988 Bracket
	SG 6951 Pan head screw coated M6x70

	SG 9917 Hirschmann portable socket-outlet STAK 3 N
	SG 10506 Pan head screw 3.9x16
	SG 10509 Countersunk head screw M5x8
	SG 10760 Bottom bar
	SG 10761 End cover
	SG 11259 Motor plate M
	SG 11321 Motor drive
	SG 11725 Motor 100-240V AC, 25-Series M10/20

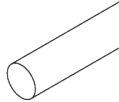
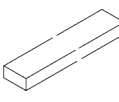
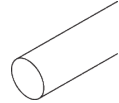
B. OPTIONAL PARTS

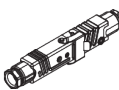
	SG 2006 Bottom bar 28x3 mm
	SG 3036 Bracket 47 mm
	SG 4752 Bottom bar plastic
	SG 4903 Bottom bar
	SG 4943 Rod ø 4 mm
	SG 4944 Side guide end cover
	SG 4946 Side guide wire rope fastener
	SG 4947 Side guide wire rope fastener
	SG 4948 Side guide wire ø 1.5 mm
	SG 4951 Bottom weight ø 8 mm
	SG 4952 Bar weight
	SG 4963 Rod ø 6 mm
	SG 8249 Side guide device
	SG 9916 Hirschmann plug set

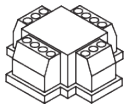
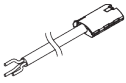
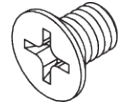
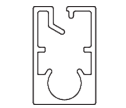
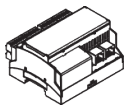
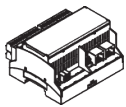
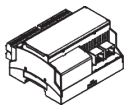
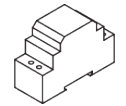
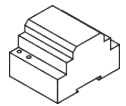
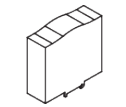
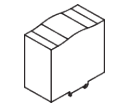
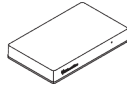
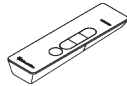
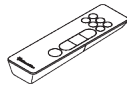
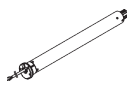
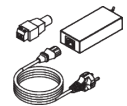
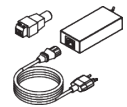
**SG 9959***Central control unit relay***SG 10293***Cable 230V AC, 2/3/5/10 m***SG 10502***Countersunk head screw M4x6***SG 10770***Bottom bar***SG 10771***End cover***SG 11178***End cover***SG 11255***Motor 24V DC, 50-Series M 10/20***SG 11260***Gateway Cedia***SG 11261***Gateway KNX***SG 11262***Expansion unit***SG 11263***Power supply 24V DC, 2.5A DIN Rail***SG 11264***Power supply 24V DC, 3.8A DIN Rail***SG 11265***Power supply 24V DC, 5A DIN Rail***SG 11266***Power supply 24V DC, 10A DIN Rail***SG 11900***Move Server***SG 11931***Radio hand held 1 channel***SG 11932***Radio hand held 6 channel***SG 11936***Radio wall transmitter 1 channel***SG 11937***Radio wall transmitter 6 channel***SG 11947***Motor 100-240V AC, 40-Series M10/20, radio receiver***SG 11948***Motor 24V DC, 40-Series M10/20, radio receiver***SG 11961***Power supply set 24V/4A with EU plug***SG 11962***Power supply set 24V/4A with CH plug*

